







Assembly code	Assembly description	Assembly image
ASM3405B/0.D02	Cooking chamber	
ASM3417A/0.D04	External cover	
ASM3433B/0.D00	Door	
ASM8227A/0.D00	Electrical system	

ASM3405B/0.D02 - Cooking chamber - FRONT



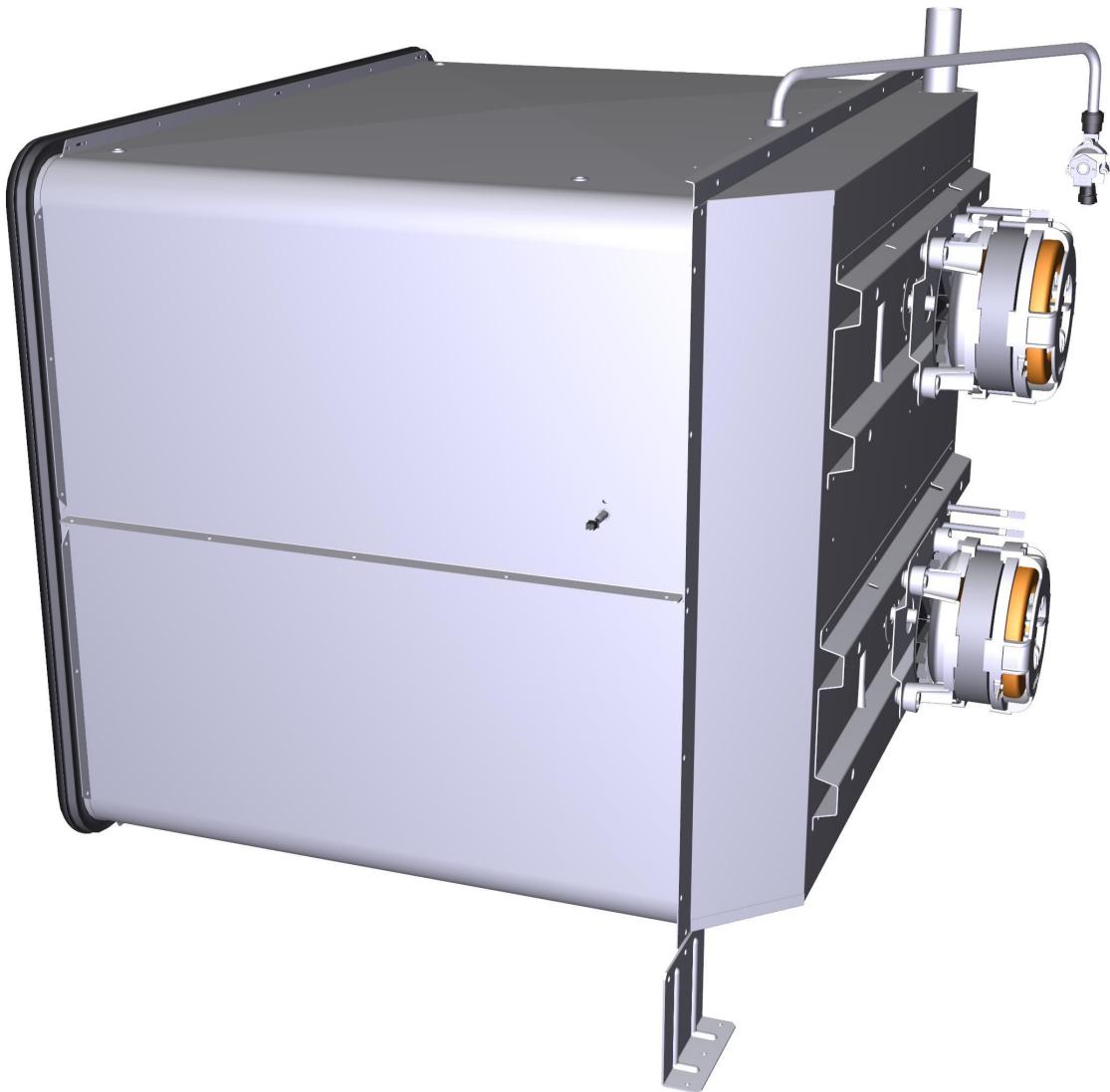







ASM3405B/0.D02 - Cooking chamber - REAR

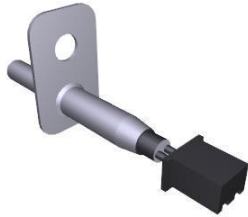



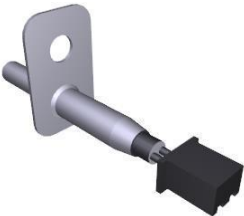



COMPONENT			SPARE PART																																		
Code	Description	Image	Code	Description	Kit components																																
0G1655A	VITTORIA SHOP PRO FAN GUARD		0G1655A0	VITTORIA SHOP PRO FAN GUARD																																	
0G1659A	VIT-CAM SP FAN GUARD SPACER		0G1659A0	VIT-CAM SP FAN GUARD SPACER																																	
0H7875A	SHOP.PRO MUFFLE SUPPORT BRACKET		0H7875A1	SHOP.PRO MUFFLE SUPPORT BRACKET																																	
TR1105A	L1000 PT100 TEMPERATURE PROBE		KTR1105A	PT100 L1000 TEMPERATURE PROBE KIT	<table border="1"> <thead> <tr> <th>Code</th> <th>Description</th> <th>Qty</th> <th>UOM</th> </tr> </thead> <tbody> <tr> <td>0H4302A0</td> <td>PROBES SILICON HOLDER</td> <td>1.000</td> <td>PC</td> </tr> <tr> <td>GN1120A1</td> <td>NTC TEMPERATUR E PROBE SEAL</td> <td>1.000</td> <td>PC</td> </tr> <tr> <td>GN1285A0</td> <td>NTC TEMPERATUR E PROBE SEALING</td> <td>1.000</td> <td>PC</td> </tr> <tr> <td>SL1045A0</td> <td>S57 BLACK SILICONE - 80ml CARTRIDGE</td> <td>1.000</td> <td>PC</td> </tr> <tr> <td>TR1105A4</td> <td>L1000 PT100 TEMPERATUR E PROBE</td> <td>1.000</td> <td>PC</td> </tr> <tr> <td>VI1220A1</td> <td>4,2x12 TCB SELF-TAPPIN G SCREW</td> <td>2.000</td> <td>PC</td> </tr> <tr> <td>VM1464A1</td> <td>CT BT TEMPERATUR E PROBE COVER</td> <td>1.000</td> <td>PC</td> </tr> </tbody> </table>	Code	Description	Qty	UOM	0H4302A0	PROBES SILICON HOLDER	1.000	PC	GN1120A1	NTC TEMPERATUR E PROBE SEAL	1.000	PC	GN1285A0	NTC TEMPERATUR E PROBE SEALING	1.000	PC	SL1045A0	S57 BLACK SILICONE - 80ml CARTRIDGE	1.000	PC	TR1105A4	L1000 PT100 TEMPERATUR E PROBE	1.000	PC	VI1220A1	4,2x12 TCB SELF-TAPPIN G SCREW	2.000	PC	VM1464A1	CT BT TEMPERATUR E PROBE COVER	1.000	PC
Code	Description	Qty	UOM																																		
0H4302A0	PROBES SILICON HOLDER	1.000	PC																																		
GN1120A1	NTC TEMPERATUR E PROBE SEAL	1.000	PC																																		
GN1285A0	NTC TEMPERATUR E PROBE SEALING	1.000	PC																																		
SL1045A0	S57 BLACK SILICONE - 80ml CARTRIDGE	1.000	PC																																		
TR1105A4	L1000 PT100 TEMPERATUR E PROBE	1.000	PC																																		
VI1220A1	4,2x12 TCB SELF-TAPPIN G SCREW	2.000	PC																																		
VM1464A1	CT BT TEMPERATUR E PROBE COVER	1.000	PC																																		







COMPONENT			SPARE PART														
Code	Description	Image	Code	Description	Kit components												
TR1105A	L1000 PT100 TEMPERATURE PROBE		KTR1105A	PT100 L1000 TEMPERATURE PROBE KIT	<table border="1"> <thead> <tr> <th>Code</th> <th>Description</th> <th>Qty</th> <th>UOM</th> </tr> </thead> <tbody> <tr> <td>VM1465A1</td> <td>CT BT TEMPERATUR E PROBE COVER</td> <td>1.000</td> <td>PC</td> </tr> <tr> <td>VM2052A0</td> <td>LM CORE PROBE COVE</td> <td>1.000</td> <td>PC</td> </tr> </tbody> </table>	Code	Description	Qty	UOM	VM1465A1	CT BT TEMPERATUR E PROBE COVER	1.000	PC	VM2052A0	LM CORE PROBE COVE	1.000	PC
Code	Description	Qty	UOM														
VM1465A1	CT BT TEMPERATUR E PROBE COVER	1.000	PC														
VM2052A0	LM CORE PROBE COVE	1.000	PC														
EL1253A	JG D8-D10 1 WAY PINK REDUCER SOLENOID		KEL1253A	1 WAY SOLENOID VALVE KIT JG D8 D1	<table border="1"> <thead> <tr> <th>Code</th> <th>Description</th> <th>Qty</th> <th>UOM</th> </tr> </thead> <tbody> <tr> <td>EL1253A0</td> <td>JG D8-D10 1 WAY PINK REDUCER SOLENOID</td> <td>1.000</td> <td>PC</td> </tr> </tbody> </table>	Code	Description	Qty	UOM	EL1253A0	JG D8-D10 1 WAY PINK REDUCER SOLENOID	1.000	PC				
Code	Description	Qty	UOM														
EL1253A0	JG D8-D10 1 WAY PINK REDUCER SOLENOID	1.000	PC														
0H3020A	MOTOR SHAFT SEALING DISC		0H3020A1	MOTOR SHAFT SEALING DISC													
0H7170A	MM MOTOR GLASS WOOL PLATE		0H7170A0	MM MOTOR GLASS WOOL PLATE													
GN1547A	SHAFT GASKET D11.8		KGN1547A	D11.6 MOTOR SHAFT GASKET 3PCS KIT	<table border="1"> <thead> <tr> <th>Code</th> <th>Description</th> <th>Qty</th> <th>UOM</th> </tr> </thead> <tbody> <tr> <td>GN1547A1</td> <td>SHAFT GASKET D11.8</td> <td>3.000</td> <td>PC</td> </tr> </tbody> </table>	Code	Description	Qty	UOM	GN1547A1	SHAFT GASKET D11.8	3.000	PC				
Code	Description	Qty	UOM														
GN1547A1	SHAFT GASKET D11.8	3.000	PC														

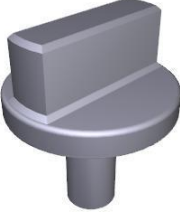

COMPONENT			SPARE PART																															
Code	Description	Image	Code	Description	Kit components																													
MT1012A	330W 230V MOTOR		KVN1130A	LUX ≤08.2017/L.MISS/S.5/ 5E MOTOR KIT	<table border="1"> <thead> <tr> <th>Code</th> <th>Description</th> <th>Qty</th> <th>UOM</th> </tr> </thead> <tbody> <tr> <td>0H8118A0</td> <td>XEVL MOTOR SHAFT DISC</td> <td>1.000</td> <td>PC</td> </tr> <tr> <td>GN1140A3</td> <td>MOLDED MOTOR HOLDER GASKET</td> <td>1.000</td> <td>PC</td> </tr> <tr> <td>VI1034A0</td> <td>STAINLESS STEEL WASHER 8.4x16x1</td> <td>1.000</td> <td>PC</td> </tr> <tr> <td>VI1256A0</td> <td>M8 DIN 980M ST. STEEL SELF LOCKING NUT</td> <td>1.000</td> <td>PC</td> </tr> <tr> <td>VM2196A0</td> <td>MOTOR NUT FASTENING BUSHING</td> <td>1.000</td> <td>PC</td> </tr> <tr> <td>VN1130A1</td> <td>330W 230V 50/60HZ MOTO</td> <td>1.000</td> <td>PC</td> </tr> </tbody> </table>	Code	Description	Qty	UOM	0H8118A0	XEVL MOTOR SHAFT DISC	1.000	PC	GN1140A3	MOLDED MOTOR HOLDER GASKET	1.000	PC	VI1034A0	STAINLESS STEEL WASHER 8.4x16x1	1.000	PC	VI1256A0	M8 DIN 980M ST. STEEL SELF LOCKING NUT	1.000	PC	VM2196A0	MOTOR NUT FASTENING BUSHING	1.000	PC	VN1130A1	330W 230V 50/60HZ MOTO	1.000	PC	
			Code	Description	Qty	UOM																												
0H8118A0	XEVL MOTOR SHAFT DISC	1.000	PC																															
GN1140A3	MOLDED MOTOR HOLDER GASKET	1.000	PC																															
VI1034A0	STAINLESS STEEL WASHER 8.4x16x1	1.000	PC																															
VI1256A0	M8 DIN 980M ST. STEEL SELF LOCKING NUT	1.000	PC																															
VM2196A0	MOTOR NUT FASTENING BUSHING	1.000	PC																															
VN1130A1	330W 230V 50/60HZ MOTO	1.000	PC																															
KMT1012A	LUX >08.2017 / MIND.MAPS 330W MOTOR KIT	<table border="1"> <thead> <tr> <th>Code</th> <th>Description</th> <th>Qty</th> <th>UOM</th> </tr> </thead> <tbody> <tr> <td>0H2842A0</td> <td>MT1012 CENTERING JI</td> <td>1.000</td> <td>PC</td> </tr> <tr> <td>0H8118A0</td> <td>XEVL MOTOR SHAFT DISC</td> <td>1.000</td> <td>PC</td> </tr> <tr> <td>GN1140A3</td> <td>MOLDED MOTOR HOLDER GASKET</td> <td>1.000</td> <td>PC</td> </tr> <tr> <td>MT1012A0</td> <td>330W 230V MOTOR</td> <td>1.000</td> <td>PC</td> </tr> <tr> <td>VI1077A1</td> <td>SCREW M6x12 TE INOX</td> <td>1.000</td> <td>PC</td> </tr> <tr> <td>VI1521A0</td> <td>STAINLESS STEEL WASHER D=6 6592</td> <td>1.000</td> <td>PC</td> </tr> <tr> <td>VI1966A1</td> <td>M4x14 FLATHEAD SCREW</td> <td>1.000</td> <td>PC</td> </tr> </tbody> </table>	Code	Description	Qty	UOM	0H2842A0	MT1012 CENTERING JI	1.000	PC	0H8118A0	XEVL MOTOR SHAFT DISC	1.000	PC	GN1140A3	MOLDED MOTOR HOLDER GASKET	1.000	PC	MT1012A0	330W 230V MOTOR	1.000	PC	VI1077A1	SCREW M6x12 TE INOX	1.000	PC	VI1521A0	STAINLESS STEEL WASHER D=6 6592	1.000	PC	VI1966A1	M4x14 FLATHEAD SCREW	1.000	PC
Code	Description	Qty	UOM																															
0H2842A0	MT1012 CENTERING JI	1.000	PC																															
0H8118A0	XEVL MOTOR SHAFT DISC	1.000	PC																															
GN1140A3	MOLDED MOTOR HOLDER GASKET	1.000	PC																															
MT1012A0	330W 230V MOTOR	1.000	PC																															
VI1077A1	SCREW M6x12 TE INOX	1.000	PC																															
VI1521A0	STAINLESS STEEL WASHER D=6 6592	1.000	PC																															
VI1966A1	M4x14 FLATHEAD SCREW	1.000	PC																															
VN1181A	M6 NUT 39 BLADES H81 D196 FAN		KVN1181A	D196 H81 39 BLADES FAN+SCREW M6 KIT	<table border="1"> <thead> <tr> <th>Code</th> <th>Description</th> <th>Qty</th> <th>UOM</th> </tr> </thead> <tbody> <tr> <td>VI1077A1</td> <td>SCREW M6x12 TE INOX</td> <td>1.000</td> <td>PC</td> </tr> <tr> <td>VI1521A0</td> <td>STAINLESS STEEL WASHER D=6 6592</td> <td>1.000</td> <td>PC</td> </tr> <tr> <td>VN1181A0</td> <td>M6 NUT 39 BLADES H81 D196 FAN</td> <td>1.000</td> <td>PC</td> </tr> </tbody> </table>	Code	Description	Qty	UOM	VI1077A1	SCREW M6x12 TE INOX	1.000	PC	VI1521A0	STAINLESS STEEL WASHER D=6 6592	1.000	PC	VN1181A0	M6 NUT 39 BLADES H81 D196 FAN	1.000	PC													
Code	Description	Qty	UOM																															
VI1077A1	SCREW M6x12 TE INOX	1.000	PC																															
VI1521A0	STAINLESS STEEL WASHER D=6 6592	1.000	PC																															
VN1181A0	M6 NUT 39 BLADES H81 D196 FAN	1.000	PC																															

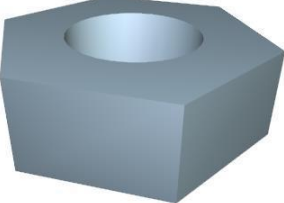

COMPONENT			SPARE PART																										
Code	Description	Image	Code	Description	Kit components																								
VN1181A	M6 NUT 39 BLADES H81 D196 FAN		KVN1030A	LUX ≤08.2017S.5/S.5E D196 FAN KIT	<table border="1"> <thead> <tr> <th>Code</th> <th>Description</th> <th>Qty</th> <th>UOM</th> </tr> </thead> <tbody> <tr> <td>VI1256A0</td> <td>M8 DIN 980M ST. STEEL SELF LOCKING NUT</td> <td>1.000</td> <td>PC</td> </tr> <tr> <td>VM2196A0</td> <td>MOTOR NUT FASTENING BUSHING</td> <td>1.000</td> <td>PC</td> </tr> <tr> <td>VN1030A5</td> <td>Ø196 H81 38 BLADES MOTOR FAN</td> <td>1.000</td> <td>PC</td> </tr> </tbody> </table>	Code	Description	Qty	UOM	VI1256A0	M8 DIN 980M ST. STEEL SELF LOCKING NUT	1.000	PC	VM2196A0	MOTOR NUT FASTENING BUSHING	1.000	PC	VN1030A5	Ø196 H81 38 BLADES MOTOR FAN	1.000	PC								
Code	Description	Qty	UOM																										
VI1256A0	M8 DIN 980M ST. STEEL SELF LOCKING NUT	1.000	PC																										
VM2196A0	MOTOR NUT FASTENING BUSHING	1.000	PC																										
VN1030A5	Ø196 H81 38 BLADES MOTOR FAN	1.000	PC																										
RS1286A	4900W 230V+400W 190V 6TURNS H100 ELEMENT		KRS1286A	6TURN HEAT ELEM 4900W 230V+400W 190V KIT	<table border="1"> <thead> <tr> <th>Code</th> <th>Description</th> <th>Qty</th> <th>UOM</th> </tr> </thead> <tbody> <tr> <td>GN1086A0</td> <td>ELEMENT SEALING</td> <td>1.000</td> <td>PC</td> </tr> <tr> <td>RS1286A0</td> <td>4900W 230V+400W 190V 6TURNS H100 ELEMEN</td> <td>1.000</td> <td>PC</td> </tr> <tr> <td>SL1045A0</td> <td>S57 BLACK SILICONE - 80ml CARTRIDGE</td> <td>1.000</td> <td>PC</td> </tr> <tr> <td>VI1220A1</td> <td>4,2x12 TCB SELF-TAPPIN G SCREW</td> <td>2.000</td> <td>PC</td> </tr> <tr> <td>VM1794A0</td> <td>250x4.8 PA66 BLACK CLAMP</td> <td>2.000</td> <td>PC</td> </tr> </tbody> </table>	Code	Description	Qty	UOM	GN1086A0	ELEMENT SEALING	1.000	PC	RS1286A0	4900W 230V+400W 190V 6TURNS H100 ELEMEN	1.000	PC	SL1045A0	S57 BLACK SILICONE - 80ml CARTRIDGE	1.000	PC	VI1220A1	4,2x12 TCB SELF-TAPPIN G SCREW	2.000	PC	VM1794A0	250x4.8 PA66 BLACK CLAMP	2.000	PC
Code	Description	Qty	UOM																										
GN1086A0	ELEMENT SEALING	1.000	PC																										
RS1286A0	4900W 230V+400W 190V 6TURNS H100 ELEMEN	1.000	PC																										
SL1045A0	S57 BLACK SILICONE - 80ml CARTRIDGE	1.000	PC																										
VI1220A1	4,2x12 TCB SELF-TAPPIN G SCREW	2.000	PC																										
VM1794A0	250x4.8 PA66 BLACK CLAMP	2.000	PC																										
GRL1501A	GRL1501A0		KGRL1501A	LATER SUPPORTS 6 600X400 BL SHOP.PRO KIT	<table border="1"> <thead> <tr> <th>Code</th> <th>Description</th> <th>Qty</th> <th>UOM</th> </tr> </thead> <tbody> <tr> <td>0H7880A0</td> <td>LEFT FLAT SUPP PROF 06EU 0H7881A-0H78 82A</td> <td>1.000</td> <td>PC</td> </tr> <tr> <td>0H7883A0</td> <td>RIGHT SUPP PROF 06EU 0H7884A-0H78 85A</td> <td>1.000</td> <td>PC</td> </tr> <tr> <td>GRL1501A0</td> <td>GRL1501A0</td> <td>1.000</td> <td>PC</td> </tr> <tr> <td>GRL1502A0</td> <td>GRL1502A0</td> <td>1.000</td> <td>PC</td> </tr> </tbody> </table>	Code	Description	Qty	UOM	0H7880A0	LEFT FLAT SUPP PROF 06EU 0H7881A-0H78 82A	1.000	PC	0H7883A0	RIGHT SUPP PROF 06EU 0H7884A-0H78 85A	1.000	PC	GRL1501A0	GRL1501A0	1.000	PC	GRL1502A0	GRL1502A0	1.000	PC				
Code	Description	Qty	UOM																										
0H7880A0	LEFT FLAT SUPP PROF 06EU 0H7881A-0H78 82A	1.000	PC																										
0H7883A0	RIGHT SUPP PROF 06EU 0H7884A-0H78 85A	1.000	PC																										
GRL1501A0	GRL1501A0	1.000	PC																										
GRL1502A0	GRL1502A0	1.000	PC																										
GRL1502A	GRL1502A0		KGRL1501A	LATER SUPPORTS 6 600X400 BL SHOP.PRO KIT	<table border="1"> <thead> <tr> <th>Code</th> <th>Description</th> <th>Qty</th> <th>UOM</th> </tr> </thead> <tbody> <tr> <td>0H7880A0</td> <td>LEFT FLAT SUPP PROF 06EU 0H7881A-0H78 82A</td> <td>1.000</td> <td>PC</td> </tr> <tr> <td>0H7883A0</td> <td>RIGHT SUPP PROF 06EU 0H7884A-0H78 85A</td> <td>1.000</td> <td>PC</td> </tr> <tr> <td>GRL1501A0</td> <td>GRL1501A0</td> <td>1.000</td> <td>PC</td> </tr> <tr> <td>GRL1502A0</td> <td>GRL1502A0</td> <td>1.000</td> <td>PC</td> </tr> </tbody> </table>	Code	Description	Qty	UOM	0H7880A0	LEFT FLAT SUPP PROF 06EU 0H7881A-0H78 82A	1.000	PC	0H7883A0	RIGHT SUPP PROF 06EU 0H7884A-0H78 85A	1.000	PC	GRL1501A0	GRL1501A0	1.000	PC	GRL1502A0	GRL1502A0	1.000	PC				
Code	Description	Qty	UOM																										
0H7880A0	LEFT FLAT SUPP PROF 06EU 0H7881A-0H78 82A	1.000	PC																										
0H7883A0	RIGHT SUPP PROF 06EU 0H7884A-0H78 85A	1.000	PC																										
GRL1501A0	GRL1501A0	1.000	PC																										
GRL1502A0	GRL1502A0	1.000	PC																										

COMPONENT			SPARE PART														
Code	Description	Image	Code	Description	Kit components												
VM1820A	LATERAL SUPPORTS M6 FIXING BOLT		KVM1820A	THUMB SCREW 10PCS KIT	<table border="1"> <thead> <tr> <th>Code</th> <th>Description</th> <th>Qty</th> <th>UOM</th> </tr> </thead> <tbody> <tr> <td>VM1820A0</td> <td>LATERAL SUPPORTS M6 FIXING BOLT</td> <td>10.000</td> <td>PC</td> </tr> </tbody> </table>	Code	Description	Qty	UOM	VM1820A0	LATERAL SUPPORTS M6 FIXING BOLT	10.000	PC				
Code	Description	Qty	UOM														
VM1820A0	LATERAL SUPPORTS M6 FIXING BOLT	10.000	PC														
VM2331A	FAN GUARD-TRAYS HOLDER PIN		KVM2331A	FAN GUARD-TRAYS HOLDER PIN 4 PCS KIT	<table border="1"> <thead> <tr> <th>Code</th> <th>Description</th> <th>Qty</th> <th>UOM</th> </tr> </thead> <tbody> <tr> <td>VM2331A0</td> <td>FAN GUARD-TRAYS HOLDER PIN</td> <td>4.000</td> <td>PC</td> </tr> </tbody> </table>	Code	Description	Qty	UOM	VM2331A0	FAN GUARD-TRAYS HOLDER PIN	4.000	PC				
Code	Description	Qty	UOM														
VM2331A0	FAN GUARD-TRAYS HOLDER PIN	4.000	PC														
GN1598A	GN1110A - SHOP.PRO VITTORIA DOOR GASKET		KGN1598A	BL SHOP.PRO VITTORIA DOOR GASKET KIT	<table border="1"> <thead> <tr> <th>Code</th> <th>Description</th> <th>Qty</th> <th>UOM</th> </tr> </thead> <tbody> <tr> <td>GN1598A1</td> <td></td> <td>1.000</td> <td>PC</td> </tr> <tr> <td>VM2277A0</td> <td>DOOR SEAL KIT INTERNAL CONNECTION</td> <td>1.000</td> <td>PC</td> </tr> </tbody> </table>	Code	Description	Qty	UOM	GN1598A1		1.000	PC	VM2277A0	DOOR SEAL KIT INTERNAL CONNECTION	1.000	PC
Code	Description	Qty	UOM														
GN1598A1		1.000	PC														
VM2277A0	DOOR SEAL KIT INTERNAL CONNECTION	1.000	PC														
RC1170A	M14 H=7 CH=22 STAINLESS STEEL NUT		KRC1170A	M14 H8 CH22 NUT - 10 PCS. KIT	<table border="1"> <thead> <tr> <th>Code</th> <th>Description</th> <th>Qty</th> <th>UOM</th> </tr> </thead> <tbody> <tr> <td>RC1170A1</td> <td>M14 H=7 CH=22 STAINLESS STEEL NUT</td> <td>10.000</td> <td>PC</td> </tr> </tbody> </table>	Code	Description	Qty	UOM	RC1170A1	M14 H=7 CH=22 STAINLESS STEEL NUT	10.000	PC				
Code	Description	Qty	UOM														
RC1170A1	M14 H=7 CH=22 STAINLESS STEEL NUT	10.000	PC														
TB1574A	FUME CHIMNEY D30 SHOP PRO		TB1574A0	FUME CHIMNEY D30 SHOP PRO													



COMPONENT			SPARE PART										
Code	Description	Image	Code	Description	Kit components								
TB1582A	VITTORIA SHOP PRO INTERNAL HUMIDITY PIPE		TB1582A0	VITTORIA SHOP PRO INTERNAL HUMIDITY PIPE									
TB1638A	ELE-VIT-CAM SP WELDED EXT HUMIDITY PIPE		TB1638A0	ELE-VIT-CAM SP WELDED EXT HUMIDITY PIPE									
VM2331A	FAN GUARD-TRAYS HOLDER PIN		KVM2331A	FAN GUARD-TRAYS HOLDER PIN 4 PCS KIT	<table border="1"> <thead> <tr> <th>Code</th> <th>Description</th> <th>Qty</th> <th>UOM</th> </tr> </thead> <tbody> <tr> <td>VM2331A0</td> <td>FAN GUARD-TRAY S HOLDER PIN</td> <td>4.000</td> <td>PC</td> </tr> </tbody> </table>	Code	Description	Qty	UOM	VM2331A0	FAN GUARD-TRAY S HOLDER PIN	4.000	PC
Code	Description	Qty	UOM										
VM2331A0	FAN GUARD-TRAY S HOLDER PIN	4.000	PC										



ASM3417A/0.D04 - External cover - FRONT













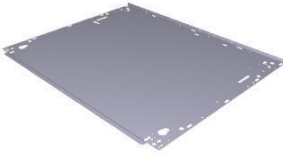

ASM3417A/0.D04 - External cover - REAR





COMPONENT			SPARE PART		
Code	Description	Image	Code	Description	Kit components
0D2412A	SP800 INF FRONT PROFILE RIGHT-LEFT DOOR		0D2412A1	SP800 INF FRONT PROFILE RIGHT-LEFT DOOR	
0D2414A	SP800 COVER		0D2414A1	SP800 COVER	
0D2461A	VITTORIA SP PUSH TO CLOSE LEFT SID		0D2461A0	VITTORIA SP PUSH TO CLOSE LEFT SID	
0D2462A	VITTORIA SP PUSH TO CLOSE RIGHT SIDE		0D2462A0	VITTORIA SP PUSH TO CLOSE RIGHT SIDE	
0E1382A	SHOP.Pro800 EXTERNAL BOTTOM PANEL		0E1382A2	SHOP.Pro800 EXTERNAL BOTTOM PANEL	





COMPONENT			SPARE PART														
Code	Description	Image	Code	Description	Kit components												
0F1545C	BACK PANEL VITTORIA SP		0F1545C1	BACK PANEL VITTORIA SP													
VM1750A	BRASS COMB CLAM		KVM1750A	COMB TERMINAL BLOCK KIT	<table border="1"> <thead> <tr> <th>Code</th> <th>Description</th> <th>Qty</th> <th>UOM</th> </tr> </thead> <tbody> <tr> <td>VI1040A0</td> <td>INDENTED INTERNAL WASHER D=6 ZN</td> <td>2.000</td> <td>PC</td> </tr> <tr> <td>VM1750A0</td> <td>BRASS COMB CLAMP</td> <td>1.000</td> <td>PC</td> </tr> </tbody> </table>	Code	Description	Qty	UOM	VI1040A0	INDENTED INTERNAL WASHER D=6 ZN	2.000	PC	VM1750A0	BRASS COMB CLAMP	1.000	PC
Code	Description	Qty	UOM														
VI1040A0	INDENTED INTERNAL WASHER D=6 ZN	2.000	PC														
VM1750A0	BRASS COMB CLAMP	1.000	PC														
VM2290A	ELECTRIC LOCKING BLIND COVER		KVM2290A	BLSP BLIND LOCKING COVER KI	<table border="1"> <thead> <tr> <th>Code</th> <th>Description</th> <th>Qty</th> <th>UOM</th> </tr> </thead> <tbody> <tr> <td>VI1024A0</td> <td>SCREW M4x12 TCB + INOX DIN 7985</td> <td>2.000</td> <td>PC</td> </tr> <tr> <td>VM2290A0</td> <td>ELECTRIC LOCKING BLIND COVER</td> <td>1.000</td> <td>PC</td> </tr> </tbody> </table>	Code	Description	Qty	UOM	VI1024A0	SCREW M4x12 TCB + INOX DIN 7985	2.000	PC	VM2290A0	ELECTRIC LOCKING BLIND COVER	1.000	PC
Code	Description	Qty	UOM														
VI1024A0	SCREW M4x12 TCB + INOX DIN 7985	2.000	PC														
VM2290A0	ELECTRIC LOCKING BLIND COVER	1.000	PC														
VM2502A	BAKERLUX SHOP.PRO CHIMNEY RING		KVM2502A	BAKERLUX SHOP.PRO CHIMNEY RING KIT	<table border="1"> <thead> <tr> <th>Code</th> <th>Description</th> <th>Qty</th> <th>UOM</th> </tr> </thead> <tbody> <tr> <td>VM2502A0</td> <td>BAKERLUX SHOP.PRO CHIMNEY RIN</td> <td>1.000</td> <td>PC</td> </tr> </tbody> </table>	Code	Description	Qty	UOM	VM2502A0	BAKERLUX SHOP.PRO CHIMNEY RIN	1.000	PC				
Code	Description	Qty	UOM														
VM2502A0	BAKERLUX SHOP.PRO CHIMNEY RIN	1.000	PC														
VM2495A	SP COOLING FAN SUPPORT		KVM2495A	COOLING FAN SUPPORT KIT	<table border="1"> <thead> <tr> <th>Code</th> <th>Description</th> <th>Qty</th> <th>UOM</th> </tr> </thead> <tbody> <tr> <td>VI1220A1</td> <td>4,2x12 TCB SELF-TAPPIN G SCREW</td> <td>2.000</td> <td>PC</td> </tr> <tr> <td>VM2495A0</td> <td>SP COOLING FAN SUPPORT</td> <td>1.000</td> <td>PC</td> </tr> </tbody> </table>	Code	Description	Qty	UOM	VI1220A1	4,2x12 TCB SELF-TAPPIN G SCREW	2.000	PC	VM2495A0	SP COOLING FAN SUPPORT	1.000	PC
Code	Description	Qty	UOM														
VI1220A1	4,2x12 TCB SELF-TAPPIN G SCREW	2.000	PC														
VM2495A0	SP COOLING FAN SUPPORT	1.000	PC														



COMPONENT			SPARE PART										
Code	Description	Image	Code	Description	Kit components								
VN1175A	230V 50/60Hz 120x120 COOLING DOWN FAN		KVN1175A	120x120 230V 50/60Hz COOLING FAN KIT	<table border="1"> <thead> <tr> <th>Code</th> <th>Description</th> <th>Qty</th> <th>UOM</th> </tr> </thead> <tbody> <tr> <td>VN1175A0</td> <td>230V 50/60Hz 120x120 COOLING DOWN FAN</td> <td>1.000</td> <td>PC</td> </tr> </tbody> </table>	Code	Description	Qty	UOM	VN1175A0	230V 50/60Hz 120x120 COOLING DOWN FAN	1.000	PC
Code	Description	Qty	UOM										
VN1175A0	230V 50/60Hz 120x120 COOLING DOWN FAN	1.000	PC										
VM2481A	FRONT EXTERNAL COVER LEFT CAP S		KVM2481A	BL SP LEFT EXT COVER FRONT PANEL CAP KIT	<table border="1"> <thead> <tr> <th>Code</th> <th>Description</th> <th>Qty</th> <th>UOM</th> </tr> </thead> <tbody> <tr> <td>VM2481A0</td> <td>FRONT EXTERNAL COVER LEFT CAP SP</td> <td>1.000</td> <td>PC</td> </tr> </tbody> </table>	Code	Description	Qty	UOM	VM2481A0	FRONT EXTERNAL COVER LEFT CAP SP	1.000	PC
Code	Description	Qty	UOM										
VM2481A0	FRONT EXTERNAL COVER LEFT CAP SP	1.000	PC										
VM2480A	FRONT EXTERNAL COVER RIGHT CAP SP		KVM2480A	BL SP RIGHT EXT COVER FRONT PANEL CAP	<table border="1"> <thead> <tr> <th>Code</th> <th>Description</th> <th>Qty</th> <th>UOM</th> </tr> </thead> <tbody> <tr> <td>VM2480A0</td> <td>FRONT EXTERNAL COVER RIGHT CAP SP</td> <td>1.000</td> <td>PC</td> </tr> </tbody> </table>	Code	Description	Qty	UOM	VM2480A0	FRONT EXTERNAL COVER RIGHT CAP SP	1.000	PC
Code	Description	Qty	UOM										
VM2480A0	FRONT EXTERNAL COVER RIGHT CAP SP	1.000	PC										
OH7850A	SHOP PRO DOOR COUNTERBRACKET		OH7850A0	SHOP PRO DOOR COUNTERBRACKET									
VI0515A	STAINLESS STEEL WASHER D=5 6592		VI0515A0	STAINLESS STEEL WASHER D=5 6592									



COMPONENT			SPARE PART																						
Code	Description	Image	Code	Description	Kit components																				
VI1995A	M5x25 ST.STEEL SCREW		VI1995A0	M5x25 ST.STEEL SCREW																					
VM1240A	NYLON SUPPORT CAP		KVM1240A	4 PCS COUNTER BRACKET SUPPORT CAP KIT	<table border="1"> <thead> <tr> <th>Code</th> <th>Description</th> <th>Qty</th> <th>UOM</th> </tr> </thead> <tbody> <tr> <td>VM1240A0</td> <td>NYLON SUPPORT CAP</td> <td>4.000</td> <td>PC</td> </tr> </tbody> </table>	Code	Description	Qty	UOM	VM1240A0	NYLON SUPPORT CAP	4.000	PC												
Code	Description	Qty	UOM																						
VM1240A0	NYLON SUPPORT CAP	4.000	PC																						
VM2459A	SP LATERAL DOOR UPPER BRACKET		KVM2459A	BL SP LATERAL DOOR UPPER BRACKET KIT	<table border="1"> <thead> <tr> <th>Code</th> <th>Description</th> <th>Qty</th> <th>UOM</th> </tr> </thead> <tbody> <tr> <td>VI0515A0</td> <td>STAINLESS STEEL WASHER D=5 6592</td> <td>4.000</td> <td>PC</td> </tr> <tr> <td>VI1995A0</td> <td>M5x25 ST.STEEL SCREW</td> <td>4.000</td> <td>PC</td> </tr> <tr> <td>VM2459A1</td> <td>SP LATERAL DOOR UPPER BRACKET</td> <td>1.000</td> <td>PC</td> </tr> <tr> <td>VM2460A0</td> <td>BL SP LATERAL DOOR UPPER BRACKET COVER</td> <td>1.000</td> <td>PC</td> </tr> </tbody> </table>	Code	Description	Qty	UOM	VI0515A0	STAINLESS STEEL WASHER D=5 6592	4.000	PC	VI1995A0	M5x25 ST.STEEL SCREW	4.000	PC	VM2459A1	SP LATERAL DOOR UPPER BRACKET	1.000	PC	VM2460A0	BL SP LATERAL DOOR UPPER BRACKET COVER	1.000	PC
Code	Description	Qty	UOM																						
VI0515A0	STAINLESS STEEL WASHER D=5 6592	4.000	PC																						
VI1995A0	M5x25 ST.STEEL SCREW	4.000	PC																						
VM2459A1	SP LATERAL DOOR UPPER BRACKET	1.000	PC																						
VM2460A0	BL SP LATERAL DOOR UPPER BRACKET COVER	1.000	PC																						
VM2460A	BL SP LATERAL DOOR UPPER BRACKET COVER		KVM2460A	BL SP LAT DOOR UPP BRACKET COVER 2PC KIT	<table border="1"> <thead> <tr> <th>Code</th> <th>Description</th> <th>Qty</th> <th>UOM</th> </tr> </thead> <tbody> <tr> <td>VM2460A0</td> <td>BL SP LATERAL DOOR UPPER BRACKET COVER</td> <td>1.000</td> <td>PC</td> </tr> </tbody> </table>	Code	Description	Qty	UOM	VM2460A0	BL SP LATERAL DOOR UPPER BRACKET COVER	1.000	PC												
Code	Description	Qty	UOM																						
VM2460A0	BL SP LATERAL DOOR UPPER BRACKET COVER	1.000	PC																						











COMPONENT			SPARE PART																						
Code	Description	Image	Code	Description	Kit components																				
0H7850A	SHOP PRO DOOR COUNTERBRACKET		0H7850A0	SHOP PRO DOOR COUNTERBRACKET																					
VI0515A	STAINLESS STEEL WASHER D=5 6592		VI0515A0	STAINLESS STEEL WASHER D=5 6592																					
VM1240A	NYLON SUPPORT CAP		KVM1240A	4 PCS COUNTER BRACKET SUPPORT CAP KIT	<table border="1"> <thead> <tr> <th>Code</th> <th>Description</th> <th>Qty</th> <th>UOM</th> </tr> </thead> <tbody> <tr> <td>VM1240A0</td> <td>NYLON SUPPORT CAP</td> <td>4.000</td> <td>PC</td> </tr> </tbody> </table>	Code	Description	Qty	UOM	VM1240A0	NYLON SUPPORT CAP	4.000	PC												
Code	Description	Qty	UOM																						
VM1240A0	NYLON SUPPORT CAP	4.000	PC																						
VM2457A	BL SP LATERAL DOOR LOWER BRACKET		KVM2457A	BL SP LATERAL DOOR LOWER BRACKET KIT	<table border="1"> <thead> <tr> <th>Code</th> <th>Description</th> <th>Qty</th> <th>UOM</th> </tr> </thead> <tbody> <tr> <td>VI0515A0</td> <td>STAINLESS STEEL WASHER D=5 6592</td> <td>2.000</td> <td>PC</td> </tr> <tr> <td>VI1995A0</td> <td>M5x25 ST.STEEL SCREW</td> <td>2.000</td> <td>PC</td> </tr> <tr> <td>VM2457A0</td> <td>BL SP LATERAL DOOR LOWER BRACKET</td> <td>1.000</td> <td>PC</td> </tr> <tr> <td>VM2458A0</td> <td>BL SP LATERAL DOOR LOW BRACKET COVER</td> <td>1.000</td> <td>PC</td> </tr> </tbody> </table>	Code	Description	Qty	UOM	VI0515A0	STAINLESS STEEL WASHER D=5 6592	2.000	PC	VI1995A0	M5x25 ST.STEEL SCREW	2.000	PC	VM2457A0	BL SP LATERAL DOOR LOWER BRACKET	1.000	PC	VM2458A0	BL SP LATERAL DOOR LOW BRACKET COVER	1.000	PC
Code	Description	Qty	UOM																						
VI0515A0	STAINLESS STEEL WASHER D=5 6592	2.000	PC																						
VI1995A0	M5x25 ST.STEEL SCREW	2.000	PC																						
VM2457A0	BL SP LATERAL DOOR LOWER BRACKET	1.000	PC																						
VM2458A0	BL SP LATERAL DOOR LOW BRACKET COVER	1.000	PC																						



COMPONENT			SPARE PART										
Code	Description	Image	Code	Description	Kit components								
VM2458A	BL SP LATERAL DOOR LOW BRACKET COVER		KVM2458A	BL SP LAT DOOR LOW BRACKET COVER 2PC KIT	<table border="1"> <thead> <tr> <th>Code</th> <th>Description</th> <th>Qty</th> <th>UOM</th> </tr> </thead> <tbody> <tr> <td>VM2458A0</td> <td>BL SP LATERAL DOOR LOW BRACKET COVER</td> <td>2.000</td> <td>PC</td> </tr> </tbody> </table>	Code	Description	Qty	UOM	VM2458A0	BL SP LATERAL DOOR LOW BRACKET COVER	2.000	PC
Code	Description	Qty	UOM										
VM2458A0	BL SP LATERAL DOOR LOW BRACKET COVER	2.000	PC										
0H7850A	SHOP PRO DOOR COUNTERBRACKET		0H7850A0	SHOP PRO DOOR COUNTERBRACKET									
VI0515A	STAINLESS STEEL WASHER D=5 6592		VI0515A0	STAINLESS STEEL WASHER D=5 6592									
VM1240A	NYLON SUPPORT CAP		KVM1240A	4 PCS COUNTER BRACKET SUPPORT CAP KIT	<table border="1"> <thead> <tr> <th>Code</th> <th>Description</th> <th>Qty</th> <th>UOM</th> </tr> </thead> <tbody> <tr> <td>VM1240A0</td> <td>NYLON SUPPORT CAP</td> <td>4.000</td> <td>PC</td> </tr> </tbody> </table>	Code	Description	Qty	UOM	VM1240A0	NYLON SUPPORT CAP	4.000	PC
Code	Description	Qty	UOM										
VM1240A0	NYLON SUPPORT CAP	4.000	PC										
VM2458A	BL SP LATERAL DOOR LOW BRACKET COVER		KVM2458A	BL SP LAT DOOR LOW BRACKET COVER 2PC KIT	<table border="1"> <thead> <tr> <th>Code</th> <th>Description</th> <th>Qty</th> <th>UOM</th> </tr> </thead> <tbody> <tr> <td>VM2458A0</td> <td>BL SP LATERAL DOOR LOW BRACKET COVER</td> <td>2.000</td> <td>PC</td> </tr> </tbody> </table>	Code	Description	Qty	UOM	VM2458A0	BL SP LATERAL DOOR LOW BRACKET COVER	2.000	PC
Code	Description	Qty	UOM										
VM2458A0	BL SP LATERAL DOOR LOW BRACKET COVER	2.000	PC										



COMPONENT			SPARE PART																						
Code	Description	Image	Code	Description	Kit components																				
VM2469A	BL SP LATERAL DOOR HOLDER BRACKET		KVM2469A	BL SP LATERAL DOOR HOLDER BRACKET KIT	<table border="1"> <thead> <tr> <th>Code</th> <th>Description</th> <th>Qty</th> <th>UOM</th> </tr> </thead> <tbody> <tr> <td>VI0515A0</td> <td>STAINLESS STEEL WASHER D=5 6592</td> <td>2.000</td> <td>PC</td> </tr> <tr> <td>VI1995A0</td> <td>M5x25 ST.STEEL SCREW</td> <td>2.000</td> <td>PC</td> </tr> <tr> <td>VM2458A0</td> <td>BL SP LATERAL DOOR LOW BRACKET COVER</td> <td>1.000</td> <td>PC</td> </tr> <tr> <td>VM2469A0</td> <td>BL SP LATERAL DOOR HOLDER BRACKET</td> <td>1.000</td> <td>PC</td> </tr> </tbody> </table>	Code	Description	Qty	UOM	VI0515A0	STAINLESS STEEL WASHER D=5 6592	2.000	PC	VI1995A0	M5x25 ST.STEEL SCREW	2.000	PC	VM2458A0	BL SP LATERAL DOOR LOW BRACKET COVER	1.000	PC	VM2469A0	BL SP LATERAL DOOR HOLDER BRACKET	1.000	PC
Code	Description	Qty	UOM																						
VI0515A0	STAINLESS STEEL WASHER D=5 6592	2.000	PC																						
VI1995A0	M5x25 ST.STEEL SCREW	2.000	PC																						
VM2458A0	BL SP LATERAL DOOR LOW BRACKET COVER	1.000	PC																						
VM2469A0	BL SP LATERAL DOOR HOLDER BRACKET	1.000	PC																						
VM2579A	SP DOOR SUPPORT CAP FOR TRANSPORT		VM2579A0	SP DOOR SUPPORT CAP FOR TRANSPORT																					
0H7850A	SHOP PRO DOOR COUNTERBRACKET		0H7850A0	SHOP PRO DOOR COUNTERBRACKET																					
VM1195A	HOLES BLANKING PLATE XVC204/304/504/704		VM1195A0	HOLES BLANKING PLATE XVC204/304/504/704																					

COMPONENT			SPARE PART																		
Code	Description	Image	Code	Description	Kit components																
VM1240A	NYLON SUPPORT CAP		KVM1240A	4 PCS COUNTER BRACKET SUPPORT CAP KIT	<table border="1"> <thead> <tr> <th>Code</th> <th>Description</th> <th>Qty</th> <th>UOM</th> </tr> </thead> <tbody> <tr> <td>VM1240A0</td> <td>NYLON SUPPORT CAP</td> <td>4.000</td> <td>PC</td> </tr> </tbody> </table>	Code	Description	Qty	UOM	VM1240A0	NYLON SUPPORT CAP	4.000	PC								
Code	Description	Qty	UOM																		
VM1240A0	NYLON SUPPORT CAP	4.000	PC																		
VM1631A	PLUS INNER GLASS PUSHING CAP		KVM1631A	CAP FOR INTERNAL GLASS 10 PCS KIT	<table border="1"> <thead> <tr> <th>Code</th> <th>Description</th> <th>Qty</th> <th>UOM</th> </tr> </thead> <tbody> <tr> <td>VM1631A0</td> <td>PLUS INNER GLASS PUSHING CAP</td> <td>10.000</td> <td>PC</td> </tr> </tbody> </table>	Code	Description	Qty	UOM	VM1631A0	PLUS INNER GLASS PUSHING CAP	10.000	PC								
Code	Description	Qty	UOM																		
VM1631A0	PLUS INNER GLASS PUSHING CAP	10.000	PC																		
VM2492A	BL SP 600x400 EXT BOTTOM PANEL GASKET		KVM2492A	SP 600X400 EXT BOT PANEL GASKET 2PC KIT	<table border="1"> <thead> <tr> <th>Code</th> <th>Description</th> <th>Qty</th> <th>UOM</th> </tr> </thead> <tbody> <tr> <td>VM1794A0</td> <td>250x4.8 PA66 BLACK CLAMP</td> <td>1.000</td> <td>PC</td> </tr> <tr> <td>VM2492A0</td> <td>BL SP 600x400 EXT BOTTOM PANEL GASKE</td> <td>2.000</td> <td>PC</td> </tr> </tbody> </table>	Code	Description	Qty	UOM	VM1794A0	250x4.8 PA66 BLACK CLAMP	1.000	PC	VM2492A0	BL SP 600x400 EXT BOTTOM PANEL GASKE	2.000	PC				
Code	Description	Qty	UOM																		
VM1794A0	250x4.8 PA66 BLACK CLAMP	1.000	PC																		
VM2492A0	BL SP 600x400 EXT BOTTOM PANEL GASKE	2.000	PC																		
VM2493A	EXT. LATERAL BACK GASKET SP800		KVM2493A	SP 600X400 BOT LAT PANEL GASKET 2PC KIT	<table border="1"> <thead> <tr> <th>Code</th> <th>Description</th> <th>Qty</th> <th>UOM</th> </tr> </thead> <tbody> <tr> <td>VM1631A0</td> <td>PLUS INNER GLASS PUSHING CAP</td> <td>4.000</td> <td>PC</td> </tr> <tr> <td>VM1794A0</td> <td>250x4.8 PA66 BLACK CLAMP</td> <td>1.000</td> <td>PC</td> </tr> <tr> <td>VM2493A1</td> <td>EXT. LATERAL BACK GASKET SP800</td> <td>2.000</td> <td>PC</td> </tr> </tbody> </table>	Code	Description	Qty	UOM	VM1631A0	PLUS INNER GLASS PUSHING CAP	4.000	PC	VM1794A0	250x4.8 PA66 BLACK CLAMP	1.000	PC	VM2493A1	EXT. LATERAL BACK GASKET SP800	2.000	PC
Code	Description	Qty	UOM																		
VM1631A0	PLUS INNER GLASS PUSHING CAP	4.000	PC																		
VM1794A0	250x4.8 PA66 BLACK CLAMP	1.000	PC																		
VM2493A1	EXT. LATERAL BACK GASKET SP800	2.000	PC																		
CR1013A	SHOP.Pro/EVEREO PUSH-TO-CLOSE LATCH		KCR1013A	BLSP/EVEREO PUSH TO CLOSE LOCK LATCH KIT	<table border="1"> <thead> <tr> <th>Code</th> <th>Description</th> <th>Qty</th> <th>UOM</th> </tr> </thead> <tbody> <tr> <td>CR1013A2</td> <td>SHOP.Pro/EVEREO PUSH-TO-CLOSE LATCH</td> <td>1.000</td> <td>PC</td> </tr> <tr> <td>VI1014A0</td> <td>STAINLESS STEEL WASHER 4.5X9X0.8</td> <td>2.000</td> <td>PC</td> </tr> <tr> <td>VI1024A0</td> <td>SCREW M4x12 TCB + INOX DIN 7985</td> <td>2.000</td> <td>PC</td> </tr> </tbody> </table>	Code	Description	Qty	UOM	CR1013A2	SHOP.Pro/EVEREO PUSH-TO-CLOSE LATCH	1.000	PC	VI1014A0	STAINLESS STEEL WASHER 4.5X9X0.8	2.000	PC	VI1024A0	SCREW M4x12 TCB + INOX DIN 7985	2.000	PC
Code	Description	Qty	UOM																		
CR1013A2	SHOP.Pro/EVEREO PUSH-TO-CLOSE LATCH	1.000	PC																		
VI1014A0	STAINLESS STEEL WASHER 4.5X9X0.8	2.000	PC																		
VI1024A0	SCREW M4x12 TCB + INOX DIN 7985	2.000	PC																		



COMPONENT			SPARE PART																		
Code	Description	Image	Code	Description	Kit components																
VE1295A	MK 16A 230V DOOR MICROSWITCH		KVE1295A	16A 230V DOOR MICROSWITCH KIT	<table border="1"> <thead> <tr> <th>Code</th> <th>Description</th> <th>Qty</th> <th>UOM</th> </tr> </thead> <tbody> <tr> <td>VE1295A0</td> <td>MK 16A 230V DOOR MICROSWITC</td> <td>1.000</td> <td>PC</td> </tr> </tbody> </table>	Code	Description	Qty	UOM	VE1295A0	MK 16A 230V DOOR MICROSWITC	1.000	PC								
Code	Description	Qty	UOM																		
VE1295A0	MK 16A 230V DOOR MICROSWITC	1.000	PC																		
VM2547A	BLSP PUSH-TO-CLOSE DOOR LATCH COVE		KVM2547A	BLSP PUSH-TO-CLOSE DOOR COVER LATCH KIT	<table border="1"> <thead> <tr> <th>Code</th> <th>Description</th> <th>Qty</th> <th>UOM</th> </tr> </thead> <tbody> <tr> <td>VI1014A0</td> <td>STAINLESS STEEL WASHER 4.5X9X0.8</td> <td>2.000</td> <td>PC</td> </tr> <tr> <td>VI1024A0</td> <td>SCREW M4x12 TCB + INOX DIN 7985</td> <td>2.000</td> <td>PC</td> </tr> <tr> <td>VM2547A1</td> <td>BLSP PUSH-TO-CLO SE DOOR LATCH COVER</td> <td>1.000</td> <td>PC</td> </tr> </tbody> </table>	Code	Description	Qty	UOM	VI1014A0	STAINLESS STEEL WASHER 4.5X9X0.8	2.000	PC	VI1024A0	SCREW M4x12 TCB + INOX DIN 7985	2.000	PC	VM2547A1	BLSP PUSH-TO-CLO SE DOOR LATCH COVER	1.000	PC
Code	Description	Qty	UOM																		
VI1014A0	STAINLESS STEEL WASHER 4.5X9X0.8	2.000	PC																		
VI1024A0	SCREW M4x12 TCB + INOX DIN 7985	2.000	PC																		
VM2547A1	BLSP PUSH-TO-CLO SE DOOR LATCH COVER	1.000	PC																		
VM1222A	CABLE LOCKS SP ACCESSORIES EL CONNECTION		VM1222A0	CABLE LOCKS SP ACCESSORIES EL CONNECTION																	
VM2249A	COOKING CHAMBER FRONT CORNER		KVM2249A	CHAMBER FRONT PROFILE CORNER KIT	<table border="1"> <thead> <tr> <th>Code</th> <th>Description</th> <th>Qty</th> <th>UOM</th> </tr> </thead> <tbody> <tr> <td>VM2249A0</td> <td>COOKING CHAMBER FRONT CORNER</td> <td>1.000</td> <td>PC</td> </tr> </tbody> </table>	Code	Description	Qty	UOM	VM2249A0	COOKING CHAMBER FRONT CORNER	1.000	PC								
Code	Description	Qty	UOM																		
VM2249A0	COOKING CHAMBER FRONT CORNER	1.000	PC																		
VM2511A	SP FRONT PANEL HOLE PLATE COVER		KVM2511A	SP FRONT PANEL HOLE PLATE COVER 2PCS KIT	<table border="1"> <thead> <tr> <th>Code</th> <th>Description</th> <th>Qty</th> <th>UOM</th> </tr> </thead> <tbody> <tr> <td>VM2511A0</td> <td>SP FRONT PANEL HOLE PLATE COVER</td> <td>2.000</td> <td>PC</td> </tr> </tbody> </table>	Code	Description	Qty	UOM	VM2511A0	SP FRONT PANEL HOLE PLATE COVER	2.000	PC								
Code	Description	Qty	UOM																		
VM2511A0	SP FRONT PANEL HOLE PLATE COVER	2.000	PC																		





ASM3433B/0.D00 - Door - FRONT







ASM3433B/0.D00 - Door - REAR



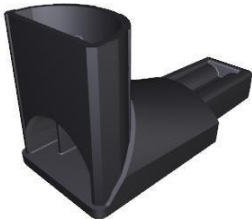



COMPONENT			SPARE PART																		
Code	Description	Image	Code	Description	Kit components																
0B1302A	SP VITTORIA RIGHT DOOR LEFT INT COLUMN		0B1302A0	SP VITTORIA RIGHT DOOR LEFT INT COLUMN																	
0B1363A	0B1363A0		0B1363A0	0B1363A0																	
LP1050A	BL SHOP.PRO L180 COMPLETE LED BA		KLP1050A	L180 COMPLETE LED LIGHT BAR KIT	<table border="1"> <thead> <tr> <th>Code</th> <th>Description</th> <th>Qty</th> <th>UOM</th> </tr> </thead> <tbody> <tr> <td>LP1050A0</td> <td>BL SHOP.PRO L180 COMPLETE LED BAR</td> <td>1.000</td> <td>PC</td> </tr> <tr> <td>VI1014A0</td> <td>STAINLESS STEEL WASHER 4.5X9X0.8</td> <td>1.000</td> <td>PC</td> </tr> <tr> <td>VI1220A1</td> <td>4,2x12 TCB SELF-TAPPING SCREW</td> <td>1.000</td> <td>PC</td> </tr> </tbody> </table>	Code	Description	Qty	UOM	LP1050A0	BL SHOP.PRO L180 COMPLETE LED BAR	1.000	PC	VI1014A0	STAINLESS STEEL WASHER 4.5X9X0.8	1.000	PC	VI1220A1	4,2x12 TCB SELF-TAPPING SCREW	1.000	PC
Code	Description	Qty	UOM																		
LP1050A0	BL SHOP.PRO L180 COMPLETE LED BAR	1.000	PC																		
VI1014A0	STAINLESS STEEL WASHER 4.5X9X0.8	1.000	PC																		
VI1220A1	4,2x12 TCB SELF-TAPPING SCREW	1.000	PC																		
VM1630A	INTERNAL GLASS PUSHING CAP		KVM1630A	CAP FOR INTERNAL GLASS 10 PCS KIT	<table border="1"> <thead> <tr> <th>Code</th> <th>Description</th> <th>Qty</th> <th>UOM</th> </tr> </thead> <tbody> <tr> <td>VM1630A1</td> <td>INTERNAL GLASS PUSHING CAP</td> <td>10.000</td> <td>PC</td> </tr> </tbody> </table>	Code	Description	Qty	UOM	VM1630A1	INTERNAL GLASS PUSHING CAP	10.000	PC								
Code	Description	Qty	UOM																		
VM1630A1	INTERNAL GLASS PUSHING CAP	10.000	PC																		
VM2479A	BL SP GLASS H6 PUSHING BRACKET		KVM2479A	BL SHOP.PRO H6 GLASS SUPPORT 6 PCS KIT	<table border="1"> <thead> <tr> <th>Code</th> <th>Description</th> <th>Qty</th> <th>UOM</th> </tr> </thead> <tbody> <tr> <td>VM1630A1</td> <td>INTERNAL GLASS PUSHING CAP</td> <td>6.000</td> <td>PC</td> </tr> <tr> <td>VM2479A0</td> <td>BL SP GLASS H6 PUSHING BRACKET</td> <td>6.000</td> <td>PC</td> </tr> </tbody> </table>	Code	Description	Qty	UOM	VM1630A1	INTERNAL GLASS PUSHING CAP	6.000	PC	VM2479A0	BL SP GLASS H6 PUSHING BRACKET	6.000	PC				
Code	Description	Qty	UOM																		
VM1630A1	INTERNAL GLASS PUSHING CAP	6.000	PC																		
VM2479A0	BL SP GLASS H6 PUSHING BRACKET	6.000	PC																		

COMPONENT			SPARE PART																										
Code	Description	Image	Code	Description	Kit components																								
TB3305A	SHOP.PRO VITTORIA FLAG DOOR HANDLE TUB		KTB3305A	BL SHOP.PRO VITTORIA HANDLE TUBE KIT	<table border="1"> <thead> <tr> <th>Code</th> <th>Description</th> <th>Qty</th> <th>UOM</th> </tr> </thead> <tbody> <tr> <td>TB3305A0</td> <td>SHOP.PRO VITTORIA FLAG DOOR HANDLE TUBE</td> <td>1.000</td> <td>PC</td> </tr> <tr> <td>VI1147A0</td> <td>5X25 STAINLESS STEEL SCREW</td> <td>4.000</td> <td>PC</td> </tr> <tr> <td>VM2456A0</td> <td>BAKERLUX SHOP.PRO HANDLE END</td> <td>1.000</td> <td>PC</td> </tr> <tr> <td>VM2489A0</td> <td>SP HANDLE END KIT + STYLUS KIT</td> <td>1.000</td> <td>PC</td> </tr> <tr> <td>VM2527A1</td> <td>EVEREO-S.Pro DISPLAY STYLUS</td> <td>1.000</td> <td>PC</td> </tr> </tbody> </table>	Code	Description	Qty	UOM	TB3305A0	SHOP.PRO VITTORIA FLAG DOOR HANDLE TUBE	1.000	PC	VI1147A0	5X25 STAINLESS STEEL SCREW	4.000	PC	VM2456A0	BAKERLUX SHOP.PRO HANDLE END	1.000	PC	VM2489A0	SP HANDLE END KIT + STYLUS KIT	1.000	PC	VM2527A1	EVEREO-S.Pro DISPLAY STYLUS	1.000	PC
					Code	Description	Qty	UOM																					
					TB3305A0	SHOP.PRO VITTORIA FLAG DOOR HANDLE TUBE	1.000	PC																					
					VI1147A0	5X25 STAINLESS STEEL SCREW	4.000	PC																					
					VM2456A0	BAKERLUX SHOP.PRO HANDLE END	1.000	PC																					
VM2489A0	SP HANDLE END KIT + STYLUS KIT	1.000	PC																										
VM2527A1	EVEREO-S.Pro DISPLAY STYLUS	1.000	PC																										
VM2456A	BAKERLUX SHOP.PRO HANDLE END		KVM2456A	2 PCS BAKERLUX SHOP.PRO HANDLE END KIT	<table border="1"> <thead> <tr> <th>Code</th> <th>Description</th> <th>Qty</th> <th>UOM</th> </tr> </thead> <tbody> <tr> <td>VI1147A0</td> <td>5X25 STAINLESS STEEL SCREW</td> <td>4.000</td> <td>PC</td> </tr> <tr> <td>VM2456A0</td> <td>BAKERLUX SHOP.PRO HANDLE END</td> <td>1.000</td> <td>PC</td> </tr> <tr> <td>VM2489A0</td> <td>SP HANDLE END KIT + STYLUS KIT</td> <td>1.000</td> <td>PC</td> </tr> <tr> <td>VM2527A1</td> <td>EVEREO-S.Pro DISPLAY STYLUS</td> <td>1.000</td> <td>PC</td> </tr> </tbody> </table>	Code	Description	Qty	UOM	VI1147A0	5X25 STAINLESS STEEL SCREW	4.000	PC	VM2456A0	BAKERLUX SHOP.PRO HANDLE END	1.000	PC	VM2489A0	SP HANDLE END KIT + STYLUS KIT	1.000	PC	VM2527A1	EVEREO-S.Pro DISPLAY STYLUS	1.000	PC				
					Code	Description	Qty	UOM																					
					VI1147A0	5X25 STAINLESS STEEL SCREW	4.000	PC																					
					VM2456A0	BAKERLUX SHOP.PRO HANDLE END	1.000	PC																					
VM2489A0	SP HANDLE END KIT + STYLUS KIT	1.000	PC																										
VM2527A1	EVEREO-S.Pro DISPLAY STYLUS	1.000	PC																										
VI1174A	VI1174A0		VI1174A0	VI1174A0																									
VM2548A	PUSH-TO-CLOSE DOOR INT PIPE GUIDE		KVM2548A	PUSH-TO-CLOSE DOOR INT PIPE GUIDE KIT	<table border="1"> <thead> <tr> <th>Code</th> <th>Description</th> <th>Qty</th> <th>UOM</th> </tr> </thead> <tbody> <tr> <td>ML1006A0</td> <td>L.21 ED7 DF1 ST STEEL TRACTION SPRING</td> <td>2.000</td> <td>PC</td> </tr> <tr> <td>VM2548A1</td> <td>PUSH-TO-CLO SE DOOR INT PIPE GUIDE</td> <td>1.000</td> <td>PC</td> </tr> <tr> <td>VM2549A0</td> <td>SP PUSH-TO-CLO SE DOOR HANDLE SPRING EYEL</td> <td>2.000</td> <td>PC</td> </tr> </tbody> </table>	Code	Description	Qty	UOM	ML1006A0	L.21 ED7 DF1 ST STEEL TRACTION SPRING	2.000	PC	VM2548A1	PUSH-TO-CLO SE DOOR INT PIPE GUIDE	1.000	PC	VM2549A0	SP PUSH-TO-CLO SE DOOR HANDLE SPRING EYEL	2.000	PC								
					Code	Description	Qty	UOM																					
					ML1006A0	L.21 ED7 DF1 ST STEEL TRACTION SPRING	2.000	PC																					
VM2548A1	PUSH-TO-CLO SE DOOR INT PIPE GUIDE	1.000	PC																										
VM2549A0	SP PUSH-TO-CLO SE DOOR HANDLE SPRING EYEL	2.000	PC																										





COMPONENT			SPARE PART																		
Code	Description	Image	Code	Description	Kit components																
VI1174A	VI1174A0		VI1174A0	VI1174A0																	
VM2468A	BL SP LEFT UPPER LATERAL DOOR CA		KVM2468A	BL SP LEFT UPPER LATERAL DOOR CAP KIT	<table border="1"> <thead> <tr> <th>Code</th> <th>Description</th> <th>Qty</th> <th>UOM</th> </tr> </thead> <tbody> <tr> <td>VM2468A0</td> <td>BL SP LEFT UPPER LATERAL DOOR CAP</td> <td>1.000</td> <td>PC</td> </tr> </tbody> </table>	Code	Description	Qty	UOM	VM2468A0	BL SP LEFT UPPER LATERAL DOOR CAP	1.000	PC								
Code	Description	Qty	UOM																		
VM2468A0	BL SP LEFT UPPER LATERAL DOOR CAP	1.000	PC																		
VM2474A	BL SP INT GLASS HINGE UPPER LOCK PIN		KVM2474A	BL SP INT GLASS HINGE UPPER LOCK PIN KIT	<table border="1"> <thead> <tr> <th>Code</th> <th>Description</th> <th>Qty</th> <th>UOM</th> </tr> </thead> <tbody> <tr> <td>VM2474A0</td> <td>BL SP INT GLASS HINGE UPPER LOCK PIN</td> <td>1.000</td> <td>PC</td> </tr> </tbody> </table>	Code	Description	Qty	UOM	VM2474A0	BL SP INT GLASS HINGE UPPER LOCK PIN	1.000	PC								
Code	Description	Qty	UOM																		
VM2474A0	BL SP INT GLASS HINGE UPPER LOCK PIN	1.000	PC																		
ML1005A	DE5 DF0.6 H18 COMPRESSION SPRING		KVM2470A	BL SHOP.PRO INTERNAL GLASS LOCK 2PCS KIT	<table border="1"> <thead> <tr> <th>Code</th> <th>Description</th> <th>Qty</th> <th>UOM</th> </tr> </thead> <tbody> <tr> <td>ML1005A0</td> <td>DES DF0.6 H18 COMPRESSION SPRING</td> <td>2.000</td> <td>PC</td> </tr> <tr> <td>VM2470A0</td> <td>SLIDE TO FIX INTERNAL GLASS SHOP.PRO</td> <td>2.000</td> <td>PC</td> </tr> <tr> <td>VM2504A0</td> <td>DOWEL TO GUIDE SLIDE SPRING SHOP.PRO</td> <td>2.000</td> <td>PC</td> </tr> </tbody> </table>	Code	Description	Qty	UOM	ML1005A0	DES DF0.6 H18 COMPRESSION SPRING	2.000	PC	VM2470A0	SLIDE TO FIX INTERNAL GLASS SHOP.PRO	2.000	PC	VM2504A0	DOWEL TO GUIDE SLIDE SPRING SHOP.PRO	2.000	PC
Code	Description	Qty	UOM																		
ML1005A0	DES DF0.6 H18 COMPRESSION SPRING	2.000	PC																		
VM2470A0	SLIDE TO FIX INTERNAL GLASS SHOP.PRO	2.000	PC																		
VM2504A0	DOWEL TO GUIDE SLIDE SPRING SHOP.PRO	2.000	PC																		
VM2470A	SLIDE TO FIX INTERNAL GLASS SHOP.PRO		KVM2470A	BL SHOP.PRO INTERNAL GLASS LOCK 2PCS KIT	<table border="1"> <thead> <tr> <th>Code</th> <th>Description</th> <th>Qty</th> <th>UOM</th> </tr> </thead> <tbody> <tr> <td>ML1005A0</td> <td>DES DF0.6 H18 COMPRESSION SPRING</td> <td>2.000</td> <td>PC</td> </tr> <tr> <td>VM2470A0</td> <td>SLIDE TO FIX INTERNAL GLASS SHOP.PRO</td> <td>2.000</td> <td>PC</td> </tr> <tr> <td>VM2504A0</td> <td>DOWEL TO GUIDE SLIDE SPRING SHOP.PRO</td> <td>2.000</td> <td>PC</td> </tr> </tbody> </table>	Code	Description	Qty	UOM	ML1005A0	DES DF0.6 H18 COMPRESSION SPRING	2.000	PC	VM2470A0	SLIDE TO FIX INTERNAL GLASS SHOP.PRO	2.000	PC	VM2504A0	DOWEL TO GUIDE SLIDE SPRING SHOP.PRO	2.000	PC
Code	Description	Qty	UOM																		
ML1005A0	DES DF0.6 H18 COMPRESSION SPRING	2.000	PC																		
VM2470A0	SLIDE TO FIX INTERNAL GLASS SHOP.PRO	2.000	PC																		
VM2504A0	DOWEL TO GUIDE SLIDE SPRING SHOP.PRO	2.000	PC																		





COMPONENT			SPARE PART																		
Code	Description	Image	Code	Description	Kit components																
VM2472A	BL SP UPPER CLAMP INT LOCK GLASS SLIDER		KVM2471A	BL SP INTERNAL GLASS LOCK HOLDER KIT	<table border="1"> <thead> <tr> <th>Code</th> <th>Description</th> <th>Qty</th> <th>UOM</th> </tr> </thead> <tbody> <tr> <td>V11998A0</td> <td>ZINC PLATED SCREW 5X30 TCB</td> <td>2.000</td> <td>PC</td> </tr> <tr> <td>VM2471A0</td> <td>BL SP LOWER CLAMP INT LOCK GLASS SLIDER</td> <td>1.000</td> <td>PC</td> </tr> <tr> <td>VM2472A0</td> <td>BL SP UPPER CLAMP INT LOCK GLASS SLIDER</td> <td>1.000</td> <td>PC</td> </tr> </tbody> </table>	Code	Description	Qty	UOM	V11998A0	ZINC PLATED SCREW 5X30 TCB	2.000	PC	VM2471A0	BL SP LOWER CLAMP INT LOCK GLASS SLIDER	1.000	PC	VM2472A0	BL SP UPPER CLAMP INT LOCK GLASS SLIDER	1.000	PC
Code	Description	Qty	UOM																		
V11998A0	ZINC PLATED SCREW 5X30 TCB	2.000	PC																		
VM2471A0	BL SP LOWER CLAMP INT LOCK GLASS SLIDER	1.000	PC																		
VM2472A0	BL SP UPPER CLAMP INT LOCK GLASS SLIDER	1.000	PC																		
VM2504A	DOWEL TO GUIDE SLIDE SPRING SHOP.PRO		KVM2470A	BL SHOP.PRO INTERNAL GLASS LOCK 2PCS KIT	<table border="1"> <thead> <tr> <th>Code</th> <th>Description</th> <th>Qty</th> <th>UOM</th> </tr> </thead> <tbody> <tr> <td>ML1005A0</td> <td>DES DF0.6 H18 COMPRESSION N SPRING</td> <td>2.000</td> <td>PC</td> </tr> <tr> <td>VM2470A0</td> <td>SLIDE TO FIX INTERNAL GLASS SHOP.PRO</td> <td>2.000</td> <td>PC</td> </tr> <tr> <td>VM2504A0</td> <td>DOWEL TO GUIDE SLIDE SPRING SHOP.PRO</td> <td>2.000</td> <td>PC</td> </tr> </tbody> </table>	Code	Description	Qty	UOM	ML1005A0	DES DF0.6 H18 COMPRESSION N SPRING	2.000	PC	VM2470A0	SLIDE TO FIX INTERNAL GLASS SHOP.PRO	2.000	PC	VM2504A0	DOWEL TO GUIDE SLIDE SPRING SHOP.PRO	2.000	PC
Code	Description	Qty	UOM																		
ML1005A0	DES DF0.6 H18 COMPRESSION N SPRING	2.000	PC																		
VM2470A0	SLIDE TO FIX INTERNAL GLASS SHOP.PRO	2.000	PC																		
VM2504A0	DOWEL TO GUIDE SLIDE SPRING SHOP.PRO	2.000	PC																		
VM2507A	SP MECH. RIGHT UPPER LATERAL DOOR CAP		KVM2507A	BLSP MEC RIGHT UPPER LAT DOOR CAP KIT	<table border="1"> <thead> <tr> <th>Code</th> <th>Description</th> <th>Qty</th> <th>UOM</th> </tr> </thead> <tbody> <tr> <td>VM2507A0</td> <td>SP MECH. RIGHT UPPER LATERAL DOOR CAP</td> <td>1.000</td> <td>PC</td> </tr> </tbody> </table>	Code	Description	Qty	UOM	VM2507A0	SP MECH. RIGHT UPPER LATERAL DOOR CAP	1.000	PC								
Code	Description	Qty	UOM																		
VM2507A0	SP MECH. RIGHT UPPER LATERAL DOOR CAP	1.000	PC																		
TB1563A	DOOR LATERAL BEAM SP800		TB1563A0	DOOR LATERAL BEAM SP800																	





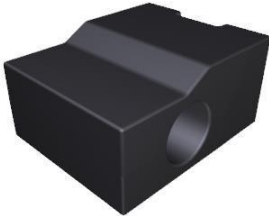

COMPONENT			SPARE PART																		
Code	Description	Image	Code	Description	Kit components																
VI1174A	VI1174A0		VI1174A0	VI1174A0																	
VI1174A	VI1174A0		VI1174A0	VI1174A0																	
VM2466A	BL SP LEFT LOWER LATERAL DOOR CA		KVM2466A	BL SP LEFT LOWER LATERAL DOOR CAP KIT	<table border="1"> <thead> <tr> <th>Code</th> <th>Description</th> <th>Qty</th> <th>UOM</th> </tr> </thead> <tbody> <tr> <td>VM2466A0</td> <td>BL SP LEFT LOWER LATERAL DOOR CAP</td> <td>1.000</td> <td>PC</td> </tr> </tbody> </table>	Code	Description	Qty	UOM	VM2466A0	BL SP LEFT LOWER LATERAL DOOR CAP	1.000	PC								
Code	Description	Qty	UOM																		
VM2466A0	BL SP LEFT LOWER LATERAL DOOR CAP	1.000	PC																		
VM2473A	BL SP INT GLASS HINGE LOWER LOCK PIN		KVM2473A	BL SP INT GLASS HINGE LOWER LOCK PIN KIT	<table border="1"> <thead> <tr> <th>Code</th> <th>Description</th> <th>Qty</th> <th>UOM</th> </tr> </thead> <tbody> <tr> <td>VM2473A0</td> <td>BL SP INT GLASS HINGE LOWER LOCK PIN</td> <td>1.000</td> <td>PC</td> </tr> </tbody> </table>	Code	Description	Qty	UOM	VM2473A0	BL SP INT GLASS HINGE LOWER LOCK PIN	1.000	PC								
Code	Description	Qty	UOM																		
VM2473A0	BL SP INT GLASS HINGE LOWER LOCK PIN	1.000	PC																		
ML1005A	DE5 DF0.6 H18 COMPRESSION SPRING		KVM2470A	BL SHOP.PRO INTERNAL GLASS LOCK 2PCS KIT	<table border="1"> <thead> <tr> <th>Code</th> <th>Description</th> <th>Qty</th> <th>UOM</th> </tr> </thead> <tbody> <tr> <td>ML1005A0</td> <td>DE5 DF0.6 H18 COMPRESSION SPRING</td> <td>2.000</td> <td>PC</td> </tr> <tr> <td>VM2470A0</td> <td>SLIDE TO FIX INTERNAL GLASS SHOP.PRO</td> <td>2.000</td> <td>PC</td> </tr> <tr> <td>VM2504A0</td> <td>DOWEL TO GUIDE SLIDE SPRING SHOP.PRO</td> <td>2.000</td> <td>PC</td> </tr> </tbody> </table>	Code	Description	Qty	UOM	ML1005A0	DE5 DF0.6 H18 COMPRESSION SPRING	2.000	PC	VM2470A0	SLIDE TO FIX INTERNAL GLASS SHOP.PRO	2.000	PC	VM2504A0	DOWEL TO GUIDE SLIDE SPRING SHOP.PRO	2.000	PC
Code	Description	Qty	UOM																		
ML1005A0	DE5 DF0.6 H18 COMPRESSION SPRING	2.000	PC																		
VM2470A0	SLIDE TO FIX INTERNAL GLASS SHOP.PRO	2.000	PC																		
VM2504A0	DOWEL TO GUIDE SLIDE SPRING SHOP.PRO	2.000	PC																		



COMPONENT			SPARE PART																		
Code	Description	Image	Code	Description	Kit components																
VM2470A	SLIDE TO FIX INTERNAL GLASS SHOP.PRO		KVM2470A	BL SHOP.PRO INTERNAL GLASS LOCK 2PCS KIT	<table border="1"> <thead> <tr> <th>Code</th> <th>Description</th> <th>Qty</th> <th>UOM</th> </tr> </thead> <tbody> <tr> <td>ML1005A0</td> <td>DES DF0.6 H18 COMPRESSIO N SPRING</td> <td>2.000</td> <td>PC</td> </tr> <tr> <td>VM2470A0</td> <td>SLIDE TO FIX INTERNAL GLASS SHOP.PRO</td> <td>2.000</td> <td>PC</td> </tr> <tr> <td>VM2504A0</td> <td>DOWEL TO GUIDE SLIDE SPRING SHOP.PRO</td> <td>2.000</td> <td>PC</td> </tr> </tbody> </table>	Code	Description	Qty	UOM	ML1005A0	DES DF0.6 H18 COMPRESSIO N SPRING	2.000	PC	VM2470A0	SLIDE TO FIX INTERNAL GLASS SHOP.PRO	2.000	PC	VM2504A0	DOWEL TO GUIDE SLIDE SPRING SHOP.PRO	2.000	PC
Code	Description	Qty	UOM																		
ML1005A0	DES DF0.6 H18 COMPRESSIO N SPRING	2.000	PC																		
VM2470A0	SLIDE TO FIX INTERNAL GLASS SHOP.PRO	2.000	PC																		
VM2504A0	DOWEL TO GUIDE SLIDE SPRING SHOP.PRO	2.000	PC																		
VM2471A	BL SP LOWER CLAMP INT LOCK GLASS SLIDER		KVM2471A	BL SP INTERNAL GLASS LOCK HOLDER KIT	<table border="1"> <thead> <tr> <th>Code</th> <th>Description</th> <th>Qty</th> <th>UOM</th> </tr> </thead> <tbody> <tr> <td>VH1998A0</td> <td>ZINC PLATED SCREW 5X30 TCB</td> <td>2.000</td> <td>PC</td> </tr> <tr> <td>VM2471A0</td> <td>BL SP LOWER CLAMP INT LOCK GLASS SLIDER</td> <td>1.000</td> <td>PC</td> </tr> <tr> <td>VM2472A0</td> <td>BL SP UPPER CLAMP INT LOCK GLASS SLIDER</td> <td>1.000</td> <td>PC</td> </tr> </tbody> </table>	Code	Description	Qty	UOM	VH1998A0	ZINC PLATED SCREW 5X30 TCB	2.000	PC	VM2471A0	BL SP LOWER CLAMP INT LOCK GLASS SLIDER	1.000	PC	VM2472A0	BL SP UPPER CLAMP INT LOCK GLASS SLIDER	1.000	PC
Code	Description	Qty	UOM																		
VH1998A0	ZINC PLATED SCREW 5X30 TCB	2.000	PC																		
VM2471A0	BL SP LOWER CLAMP INT LOCK GLASS SLIDER	1.000	PC																		
VM2472A0	BL SP UPPER CLAMP INT LOCK GLASS SLIDER	1.000	PC																		
VM2504A	DOWEL TO GUIDE SLIDE SPRING SHOP.PRO		KVM2470A	BL SHOP.PRO INTERNAL GLASS LOCK 2PCS KIT	<table border="1"> <thead> <tr> <th>Code</th> <th>Description</th> <th>Qty</th> <th>UOM</th> </tr> </thead> <tbody> <tr> <td>ML1005A0</td> <td>DES DF0.6 H18 COMPRESSIO N SPRING</td> <td>2.000</td> <td>PC</td> </tr> <tr> <td>VM2470A0</td> <td>SLIDE TO FIX INTERNAL GLASS SHOP.PRO</td> <td>2.000</td> <td>PC</td> </tr> <tr> <td>VM2504A0</td> <td>DOWEL TO GUIDE SLIDE SPRING SHOP.PRO</td> <td>2.000</td> <td>PC</td> </tr> </tbody> </table>	Code	Description	Qty	UOM	ML1005A0	DES DF0.6 H18 COMPRESSIO N SPRING	2.000	PC	VM2470A0	SLIDE TO FIX INTERNAL GLASS SHOP.PRO	2.000	PC	VM2504A0	DOWEL TO GUIDE SLIDE SPRING SHOP.PRO	2.000	PC
Code	Description	Qty	UOM																		
ML1005A0	DES DF0.6 H18 COMPRESSIO N SPRING	2.000	PC																		
VM2470A0	SLIDE TO FIX INTERNAL GLASS SHOP.PRO	2.000	PC																		
VM2504A0	DOWEL TO GUIDE SLIDE SPRING SHOP.PRO	2.000	PC																		
VM2506A	SP MECH. RIGHT LOWER LATERAL DOOR CAP		KVM2506A	BLSP MEC RIGHT LOWER LAT DOOR CAP KIT	<table border="1"> <thead> <tr> <th>Code</th> <th>Description</th> <th>Qty</th> <th>UOM</th> </tr> </thead> <tbody> <tr> <td>VM2506A0</td> <td>SP MECH. RIGHT LOWER LATERAL DOOR CAP</td> <td>1.000</td> <td>PC</td> </tr> </tbody> </table>	Code	Description	Qty	UOM	VM2506A0	SP MECH. RIGHT LOWER LATERAL DOOR CAP	1.000	PC								
Code	Description	Qty	UOM																		
VM2506A0	SP MECH. RIGHT LOWER LATERAL DOOR CAP	1.000	PC																		

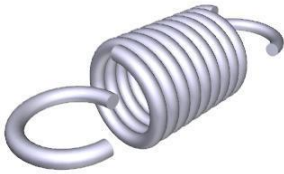

COMPONENT			SPARE PART																		
Code	Description	Image	Code	Description	Kit components																
TB1563A	DOOR LATERAL BEAM SP800		TB1563A0	DOOR LATERAL BEAM SP800																	
VI1174A	VI1174A0		VI1174A0	VI1174A0																	
VM2546A	SP COVER PUSH-TO-CLOSE DOOR HOOK		KVM2546A	BLSP COVER PUSH-TO-CLOSE DOOR HOOK KIT	<table border="1"> <thead> <tr> <th>Code</th> <th>Description</th> <th>Qty</th> <th>UOM</th> </tr> </thead> <tbody> <tr> <td>VI1014A0</td> <td>STAINLESS STEEL WASHER 4.5X9X0.8</td> <td>2.000</td> <td>PC</td> </tr> <tr> <td>VI1024A0</td> <td>SCREW M4x12 TCB + INOX DIN 7985</td> <td>2.000</td> <td>PC</td> </tr> <tr> <td>VM2546A1</td> <td>SP COVER PUSH-TO-CLOSE DOOR HOOK</td> <td>1.000</td> <td>PC</td> </tr> </tbody> </table>	Code	Description	Qty	UOM	VI1014A0	STAINLESS STEEL WASHER 4.5X9X0.8	2.000	PC	VI1024A0	SCREW M4x12 TCB + INOX DIN 7985	2.000	PC	VM2546A1	SP COVER PUSH-TO-CLOSE DOOR HOOK	1.000	PC
Code	Description	Qty	UOM																		
VI1014A0	STAINLESS STEEL WASHER 4.5X9X0.8	2.000	PC																		
VI1024A0	SCREW M4x12 TCB + INOX DIN 7985	2.000	PC																		
VM2546A1	SP COVER PUSH-TO-CLOSE DOOR HOOK	1.000	PC																		
CE1096A	4 POLES MICROFIT 3 M BUS CABLE		KCE1096A	3 M POWER-CONTROL 4 POLES BUS CABLE KIT	<table border="1"> <thead> <tr> <th>Code</th> <th>Description</th> <th>Qty</th> <th>UOM</th> </tr> </thead> <tbody> <tr> <td>CE1096A0</td> <td>4 POLES MICROFIT 3 M BUS CABLE</td> <td>1.000</td> <td>PC</td> </tr> </tbody> </table>	Code	Description	Qty	UOM	CE1096A0	4 POLES MICROFIT 3 M BUS CABLE	1.000	PC								
Code	Description	Qty	UOM																		
CE1096A0	4 POLES MICROFIT 3 M BUS CABLE	1.000	PC																		
CE1285A	EMI ROUND FERRITE MOD.2643801502		KCE1285A	ROUND FERRITE ELECTROMAGN PROT. 2PCS KIT	<table border="1"> <thead> <tr> <th>Code</th> <th>Description</th> <th>Qty</th> <th>UOM</th> </tr> </thead> <tbody> <tr> <td>CE1285A0</td> <td>EMI ROUND FERRITE MOD.2643801502</td> <td>2.000</td> <td>PC</td> </tr> </tbody> </table>	Code	Description	Qty	UOM	CE1285A0	EMI ROUND FERRITE MOD.2643801502	2.000	PC								
Code	Description	Qty	UOM																		
CE1285A0	EMI ROUND FERRITE MOD.2643801502	2.000	PC																		

COMPONENT			SPARE PART																																						
Code	Description	Image	Code	Description	Kit components																																				
ML1006A	L.21 ED7 DF1 ST STEEL TRACTION SPRING		KML1006A	L21 De7 Df1 TRACTION SPRING 10PCS KIT	<table border="1"> <thead> <tr> <th>Code</th> <th>Description</th> <th>Qty</th> <th>UOM</th> </tr> </thead> <tbody> <tr> <td>ML1006A0</td> <td>L.21 ED7 DF1 ST STEEL TRACTION SPRING</td> <td>10.000</td> <td>PC</td> </tr> </tbody> </table>	Code	Description	Qty	UOM	ML1006A0	L.21 ED7 DF1 ST STEEL TRACTION SPRING	10.000	PC																												
Code	Description	Qty	UOM																																						
ML1006A0	L.21 ED7 DF1 ST STEEL TRACTION SPRING	10.000	PC																																						
PE2107A	BAKERLUX SHOP.PRO LED COMPLETE CONTROL		KPE2107A	BAKERLUX SP LED CONTROL BOARD KIT	<table border="1"> <thead> <tr> <th>Code</th> <th>Description</th> <th>Qty</th> <th>UOM</th> </tr> </thead> <tbody> <tr> <td>PE2107A2</td> <td>BAKERLUX SHOP.PRO LED COMPLETE CONTROL</td> <td>1.000</td> <td>PC</td> </tr> <tr> <td>VI1147A0</td> <td>5X25 STAINLESS STEEL SCREW</td> <td>2.000</td> <td>PC</td> </tr> <tr> <td>VM1447A0</td> <td></td> <td>1.000</td> <td>PC</td> </tr> </tbody> </table>	Code	Description	Qty	UOM	PE2107A2	BAKERLUX SHOP.PRO LED COMPLETE CONTROL	1.000	PC	VI1147A0	5X25 STAINLESS STEEL SCREW	2.000	PC	VM1447A0		1.000	PC																				
Code	Description	Qty	UOM																																						
PE2107A2	BAKERLUX SHOP.PRO LED COMPLETE CONTROL	1.000	PC																																						
VI1147A0	5X25 STAINLESS STEEL SCREW	2.000	PC																																						
VM1447A0		1.000	PC																																						
VI1174A	VI1174A0		VI1174A0	VI1174A0																																					
VM2274A	GROOVED BUSHING		KVM2274A K0B1126AR	GROOVED PIN BUSHING KIT BAKERTOP MM RIGHT DOOR LOWER BEAM KIT	<table border="1"> <thead> <tr> <th>Code</th> <th>Description</th> <th>Qty</th> <th>UOM</th> </tr> </thead> <tbody> <tr> <td>VM2274A0</td> <td>GROOVED BUSHING</td> <td>1.000</td> <td>PC</td> </tr> <tr> <td>OB1126A1</td> <td>860mm DOOR LOWER FRAME SHAPE</td> <td>1.000</td> <td>PC</td> </tr> <tr> <td>RC1200A0</td> <td>ED=4 WIRE D=0.5 H24 COMPRESSIO N SPRING</td> <td>2.000</td> <td>PC</td> </tr> <tr> <td>VI1220A1</td> <td>4,2x12 TCB SELF-TAPPIN G SCREW</td> <td>1.000</td> <td>PC</td> </tr> <tr> <td>VI1996A0</td> <td>M5x35 SCREW</td> <td>7.000</td> <td>PC</td> </tr> <tr> <td>VM1794A0</td> <td>250x4.8 PA66 BLACK CLAMP</td> <td>2.000</td> <td>PC</td> </tr> <tr> <td>VM2259A1</td> <td>6 SERIES DOOR LOWER LEFT CAP</td> <td>1.000</td> <td>PC</td> </tr> <tr> <td>VM2261A1</td> <td>MM DOOR LOWER RIGHT CAP</td> <td>1.000</td> <td>PC</td> </tr> </tbody> </table>	Code	Description	Qty	UOM	VM2274A0	GROOVED BUSHING	1.000	PC	OB1126A1	860mm DOOR LOWER FRAME SHAPE	1.000	PC	RC1200A0	ED=4 WIRE D=0.5 H24 COMPRESSIO N SPRING	2.000	PC	VI1220A1	4,2x12 TCB SELF-TAPPIN G SCREW	1.000	PC	VI1996A0	M5x35 SCREW	7.000	PC	VM1794A0	250x4.8 PA66 BLACK CLAMP	2.000	PC	VM2259A1	6 SERIES DOOR LOWER LEFT CAP	1.000	PC	VM2261A1	MM DOOR LOWER RIGHT CAP	1.000	PC
Code	Description	Qty	UOM																																						
VM2274A0	GROOVED BUSHING	1.000	PC																																						
OB1126A1	860mm DOOR LOWER FRAME SHAPE	1.000	PC																																						
RC1200A0	ED=4 WIRE D=0.5 H24 COMPRESSIO N SPRING	2.000	PC																																						
VI1220A1	4,2x12 TCB SELF-TAPPIN G SCREW	1.000	PC																																						
VI1996A0	M5x35 SCREW	7.000	PC																																						
VM1794A0	250x4.8 PA66 BLACK CLAMP	2.000	PC																																						
VM2259A1	6 SERIES DOOR LOWER LEFT CAP	1.000	PC																																						
VM2261A1	MM DOOR LOWER RIGHT CAP	1.000	PC																																						



COMPONENT			SPARE PART																																															
Code	Description	Image	Code	Description	Kit components																																													
VM2274A	GROOVED BUSHING		K0B1126AR	BAKERTOP MM RIGHT DOOR LOWER BEAM KIT	<table border="1"> <thead> <tr> <th>Code</th> <th>Description</th> <th>Qty</th> <th>UOM</th> </tr> </thead> <tbody> <tr> <td>VM2267A1</td> <td>INNER GLASS LOCKING SYSTEM SLIDER</td> <td>1.000</td> <td>PC</td> </tr> <tr> <td>VM2269A0</td> <td>INTERNAL GLASS LOCKING SYSTEM CAP</td> <td>1.000</td> <td>PC</td> </tr> <tr> <td>VM2274A0</td> <td>GROOVED BUSHING</td> <td>1.000</td> <td>PC</td> </tr> <tr> <td>VM2305A0</td> <td>MM SERIES DOOR CAP FIXING PAWL</td> <td>7.000</td> <td>PC</td> </tr> </tbody> </table>	Code	Description	Qty	UOM	VM2267A1	INNER GLASS LOCKING SYSTEM SLIDER	1.000	PC	VM2269A0	INTERNAL GLASS LOCKING SYSTEM CAP	1.000	PC	VM2274A0	GROOVED BUSHING	1.000	PC	VM2305A0	MM SERIES DOOR CAP FIXING PAWL	7.000	PC																									
			Code	Description	Qty	UOM																																												
			VM2267A1	INNER GLASS LOCKING SYSTEM SLIDER	1.000	PC																																												
VM2269A0	INTERNAL GLASS LOCKING SYSTEM CAP	1.000	PC																																															
VM2274A0	GROOVED BUSHING	1.000	PC																																															
VM2305A0	MM SERIES DOOR CAP FIXING PAWL	7.000	PC																																															
K0B1126AL	EU AND 2/1 MM LEFT DOOR LOWER BEAM KIT	<table border="1"> <thead> <tr> <th>Code</th> <th>Description</th> <th>Qty</th> <th>UOM</th> </tr> </thead> <tbody> <tr> <td>0B1126A1</td> <td>860mm DOOR LOWER FRAME SHAPE</td> <td>1.000</td> <td>PC</td> </tr> <tr> <td>RC1200A0</td> <td>ED=4 WIRE D=0.5 H24 COMPRESSIO N SPRING</td> <td>2.000</td> <td>PC</td> </tr> <tr> <td>VI1220A1</td> <td>4,2x12 TCB SELF-TAPPIN G SCREW</td> <td>1.000</td> <td>PC</td> </tr> <tr> <td>VI1996A0</td> <td>M5x35 SCREW</td> <td>7.000</td> <td>PC</td> </tr> <tr> <td>VM1794A0</td> <td>250x4.8 PA66 BLACK CLAMP</td> <td>2.000</td> <td>PC</td> </tr> <tr> <td>VM2267A1</td> <td>INNER GLASS LOCKING SYSTEM SLIDER</td> <td>1.000</td> <td>PC</td> </tr> <tr> <td>VM2269A0</td> <td>INTERNAL GLASS LOCKING SYSTEM CAP</td> <td>1.000</td> <td>PC</td> </tr> <tr> <td>VM2274A0</td> <td>GROOVED BUSHING</td> <td>1.000</td> <td>PC</td> </tr> <tr> <td>VM2305A0</td> <td>MM SERIES DOOR CAP FIXING PAWL</td> <td>7.000</td> <td>PC</td> </tr> <tr> <td>VM2384A0</td> <td>MM LEFT DOOR RIGHT LOWER CAP</td> <td>1.000</td> <td>PC</td> </tr> <tr> <td>VM2386A1</td> <td>LEFT MM DOOR LOWER LEFT CAP</td> <td>1.000</td> <td>PC</td> </tr> </tbody> </table>	Code	Description	Qty	UOM	0B1126A1	860mm DOOR LOWER FRAME SHAPE	1.000	PC	RC1200A0	ED=4 WIRE D=0.5 H24 COMPRESSIO N SPRING	2.000	PC	VI1220A1	4,2x12 TCB SELF-TAPPIN G SCREW	1.000	PC	VI1996A0	M5x35 SCREW	7.000	PC	VM1794A0	250x4.8 PA66 BLACK CLAMP	2.000	PC	VM2267A1	INNER GLASS LOCKING SYSTEM SLIDER	1.000	PC	VM2269A0	INTERNAL GLASS LOCKING SYSTEM CAP	1.000	PC	VM2274A0	GROOVED BUSHING	1.000	PC	VM2305A0	MM SERIES DOOR CAP FIXING PAWL	7.000	PC	VM2384A0	MM LEFT DOOR RIGHT LOWER CAP	1.000	PC	VM2386A1	LEFT MM DOOR LOWER LEFT CAP	1.000	PC
Code	Description	Qty	UOM																																															
0B1126A1	860mm DOOR LOWER FRAME SHAPE	1.000	PC																																															
RC1200A0	ED=4 WIRE D=0.5 H24 COMPRESSIO N SPRING	2.000	PC																																															
VI1220A1	4,2x12 TCB SELF-TAPPIN G SCREW	1.000	PC																																															
VI1996A0	M5x35 SCREW	7.000	PC																																															
VM1794A0	250x4.8 PA66 BLACK CLAMP	2.000	PC																																															
VM2267A1	INNER GLASS LOCKING SYSTEM SLIDER	1.000	PC																																															
VM2269A0	INTERNAL GLASS LOCKING SYSTEM CAP	1.000	PC																																															
VM2274A0	GROOVED BUSHING	1.000	PC																																															
VM2305A0	MM SERIES DOOR CAP FIXING PAWL	7.000	PC																																															
VM2384A0	MM LEFT DOOR RIGHT LOWER CAP	1.000	PC																																															
VM2386A1	LEFT MM DOOR LOWER LEFT CAP	1.000	PC																																															
K0B1122AR	CHEFTOP MM RIGHT DOOR LOWER BEAM KIT	<table border="1"> <thead> <tr> <th>Code</th> <th>Description</th> <th>Qty</th> <th>UOM</th> </tr> </thead> <tbody> <tr> <td>0B1122A1</td> <td>750MM DOOR LOWER FRAME SHAPE</td> <td>1.000</td> <td>PC</td> </tr> </tbody> </table>	Code	Description	Qty	UOM	0B1122A1	750MM DOOR LOWER FRAME SHAPE	1.000	PC																																								
Code	Description	Qty	UOM																																															
0B1122A1	750MM DOOR LOWER FRAME SHAPE	1.000	PC																																															



COMPONENT			SPARE PART																																										
Code	Description	Image	Code	Description	Kit components																																								
VM2274A	GROOVED BUSHING		K0B1122AR	CHEFTOP MM RIGHT DOOR LOWER BEAM KIT	<table border="1"> <thead> <tr> <th>Code</th> <th>Description</th> <th>Qty</th> <th>UOM</th> </tr> </thead> <tbody> <tr> <td>RC1200A0</td> <td>ED=4 WIRE D=0.5 H24 COMPRESSIO N SPRING</td> <td>2.000</td> <td>PC</td> </tr> <tr> <td>V11220A1</td> <td>4,2x12 TCB SELF-TAPPIN G SCREW</td> <td>1.000</td> <td>PC</td> </tr> <tr> <td>V11996A0</td> <td>M5x35 SCREW</td> <td>7.000</td> <td>PC</td> </tr> <tr> <td>VM2259A1</td> <td>6 SERIES DOOR LOWER LEFT CAP</td> <td>1.000</td> <td>PC</td> </tr> <tr> <td>VM2261A1</td> <td>MM DOOR LOWER RIGHT CAP</td> <td>1.000</td> <td>PC</td> </tr> <tr> <td>VM2267A1</td> <td>INNER GLASS LOCKING SYSTEM SLIDER</td> <td>1.000</td> <td>PC</td> </tr> <tr> <td>VM2269A0</td> <td>INTERNAL GLASS LOCKING SYSTEM CAP</td> <td>1.000</td> <td>PC</td> </tr> <tr> <td>VM2274A0</td> <td>GROOVED BUSHING</td> <td>1.000</td> <td>PC</td> </tr> <tr> <td>VM2305A0</td> <td>MM SERIES DOOR CAP FIXING PAWL</td> <td>7.000</td> <td>PC</td> </tr> </tbody> </table>	Code	Description	Qty	UOM	RC1200A0	ED=4 WIRE D=0.5 H24 COMPRESSIO N SPRING	2.000	PC	V11220A1	4,2x12 TCB SELF-TAPPIN G SCREW	1.000	PC	V11996A0	M5x35 SCREW	7.000	PC	VM2259A1	6 SERIES DOOR LOWER LEFT CAP	1.000	PC	VM2261A1	MM DOOR LOWER RIGHT CAP	1.000	PC	VM2267A1	INNER GLASS LOCKING SYSTEM SLIDER	1.000	PC	VM2269A0	INTERNAL GLASS LOCKING SYSTEM CAP	1.000	PC	VM2274A0	GROOVED BUSHING	1.000	PC	VM2305A0	MM SERIES DOOR CAP FIXING PAWL	7.000	PC
			Code	Description	Qty	UOM																																							
RC1200A0	ED=4 WIRE D=0.5 H24 COMPRESSIO N SPRING	2.000	PC																																										
V11220A1	4,2x12 TCB SELF-TAPPIN G SCREW	1.000	PC																																										
V11996A0	M5x35 SCREW	7.000	PC																																										
VM2259A1	6 SERIES DOOR LOWER LEFT CAP	1.000	PC																																										
VM2261A1	MM DOOR LOWER RIGHT CAP	1.000	PC																																										
VM2267A1	INNER GLASS LOCKING SYSTEM SLIDER	1.000	PC																																										
VM2269A0	INTERNAL GLASS LOCKING SYSTEM CAP	1.000	PC																																										
VM2274A0	GROOVED BUSHING	1.000	PC																																										
VM2305A0	MM SERIES DOOR CAP FIXING PAWL	7.000	PC																																										
K0B1122AL	CHEFTOP MM LEFT DOOR LOWER BEAM KIT	<table border="1"> <thead> <tr> <th>Code</th> <th>Description</th> <th>Qty</th> <th>UOM</th> </tr> </thead> <tbody> <tr> <td>0B1122A1</td> <td>750MM DOOR LOWER FRAME SHAPE</td> <td>1.000</td> <td>PC</td> </tr> <tr> <td>RC1200A0</td> <td>ED=4 WIRE D=0.5 H24 COMPRESSIO N SPRING</td> <td>2.000</td> <td>PC</td> </tr> <tr> <td>V11220A1</td> <td>4,2x12 TCB SELF-TAPPIN G SCREW</td> <td>1.000</td> <td>PC</td> </tr> <tr> <td>V11996A0</td> <td>M5x35 SCREW</td> <td>7.000</td> <td>PC</td> </tr> <tr> <td>VM1794A0</td> <td>250x4.8 PA66 BLACK CLAMP</td> <td>2.000</td> <td>PC</td> </tr> <tr> <td>VM2267A1</td> <td>INNER GLASS LOCKING SYSTEM SLIDER</td> <td>1.000</td> <td>PC</td> </tr> <tr> <td>VM2269A0</td> <td>INTERNAL GLASS LOCKING SYSTEM CAP</td> <td>1.000</td> <td>PC</td> </tr> <tr> <td>VM2274A0</td> <td>GROOVED BUSHING</td> <td>1.000</td> <td>PC</td> </tr> <tr> <td>VM2305A0</td> <td>MM SERIES DOOR CAP FIXING PAWL</td> <td>7.000</td> <td>PC</td> </tr> </tbody> </table>	Code	Description	Qty	UOM	0B1122A1	750MM DOOR LOWER FRAME SHAPE	1.000	PC	RC1200A0	ED=4 WIRE D=0.5 H24 COMPRESSIO N SPRING	2.000	PC	V11220A1	4,2x12 TCB SELF-TAPPIN G SCREW	1.000	PC	V11996A0	M5x35 SCREW	7.000	PC	VM1794A0	250x4.8 PA66 BLACK CLAMP	2.000	PC	VM2267A1	INNER GLASS LOCKING SYSTEM SLIDER	1.000	PC	VM2269A0	INTERNAL GLASS LOCKING SYSTEM CAP	1.000	PC	VM2274A0	GROOVED BUSHING	1.000	PC	VM2305A0	MM SERIES DOOR CAP FIXING PAWL	7.000	PC			
Code	Description	Qty	UOM																																										
0B1122A1	750MM DOOR LOWER FRAME SHAPE	1.000	PC																																										
RC1200A0	ED=4 WIRE D=0.5 H24 COMPRESSIO N SPRING	2.000	PC																																										
V11220A1	4,2x12 TCB SELF-TAPPIN G SCREW	1.000	PC																																										
V11996A0	M5x35 SCREW	7.000	PC																																										
VM1794A0	250x4.8 PA66 BLACK CLAMP	2.000	PC																																										
VM2267A1	INNER GLASS LOCKING SYSTEM SLIDER	1.000	PC																																										
VM2269A0	INTERNAL GLASS LOCKING SYSTEM CAP	1.000	PC																																										
VM2274A0	GROOVED BUSHING	1.000	PC																																										
VM2305A0	MM SERIES DOOR CAP FIXING PAWL	7.000	PC																																										

COMPONENT			SPARE PART																						
Code	Description	Image	Code	Description	Kit components																				
VM2274A	GROOVED BUSHING		K0B1122AL	CHEFTOP MM LEFT DOOR LOWER BEAM KIT	<table border="1"> <thead> <tr> <th>Code</th> <th>Description</th> <th>Qty</th> <th>UOM</th> </tr> </thead> <tbody> <tr> <td>VM2384A0</td> <td>MM LEFT DOOR RIGHT LOWER CAP</td> <td>1.000</td> <td>PC</td> </tr> <tr> <td>VM2386A1</td> <td>LEFT MM DOOR LOWER LEFT CAP</td> <td>1.000</td> <td>PC</td> </tr> </tbody> </table>	Code	Description	Qty	UOM	VM2384A0	MM LEFT DOOR RIGHT LOWER CAP	1.000	PC	VM2386A1	LEFT MM DOOR LOWER LEFT CAP	1.000	PC								
Code	Description	Qty	UOM																						
VM2384A0	MM LEFT DOOR RIGHT LOWER CAP	1.000	PC																						
VM2386A1	LEFT MM DOOR LOWER LEFT CAP	1.000	PC																						
VM2275A	SMOOTH BUSHING		KVM2275A	SMOOTH PIN BUSHING KIT	<table border="1"> <thead> <tr> <th>Code</th> <th>Description</th> <th>Qty</th> <th>UOM</th> </tr> </thead> <tbody> <tr> <td>VM2275A0</td> <td>SMOOTH BUSHING</td> <td>1.000</td> <td>PC</td> </tr> </tbody> </table>	Code	Description	Qty	UOM	VM2275A0	SMOOTH BUSHING	1.000	PC												
Code	Description	Qty	UOM																						
VM2275A0	SMOOTH BUSHING	1.000	PC																						
VM2512A	BL SP DOOR-MICROSWITCH SOFT CLOSING		KVM2512A	BL SP DOOR-MICROSWITCH SOFT CLOSING KIT	<table border="1"> <thead> <tr> <th>Code</th> <th>Description</th> <th>Qty</th> <th>UOM</th> </tr> </thead> <tbody> <tr> <td>VM2512A0</td> <td>BL SP DOOR-MICROSWITCH SOFT CLOSING</td> <td>1.000</td> <td>PC</td> </tr> </tbody> </table>	Code	Description	Qty	UOM	VM2512A0	BL SP DOOR-MICROSWITCH SOFT CLOSING	1.000	PC												
Code	Description	Qty	UOM																						
VM2512A0	BL SP DOOR-MICROSWITCH SOFT CLOSING	1.000	PC																						
VM2549A	SP PUSH-TO-CLOSE DOOR HANDLE SPRING EYEL		KVM2548A	PUSH-TO-CLOSE DOOR INT PIPE GUIDE KIT	<table border="1"> <thead> <tr> <th>Code</th> <th>Description</th> <th>Qty</th> <th>UOM</th> </tr> </thead> <tbody> <tr> <td>ML1006A0</td> <td>L21 ED7 DF1 ST STEEL TRACTION SPRING</td> <td>2.000</td> <td>PC</td> </tr> <tr> <td>VM2548A1</td> <td>PUSH-TO-CLOSE DOOR INT PIPE GUIDE</td> <td>1.000</td> <td>PC</td> </tr> <tr> <td>VM2549A0</td> <td>SP PUSH-TO-CLOSE DOOR HANDLE SPRING EYEL</td> <td>2.000</td> <td>PC</td> </tr> </tbody> </table>	Code	Description	Qty	UOM	ML1006A0	L21 ED7 DF1 ST STEEL TRACTION SPRING	2.000	PC	VM2548A1	PUSH-TO-CLOSE DOOR INT PIPE GUIDE	1.000	PC	VM2549A0	SP PUSH-TO-CLOSE DOOR HANDLE SPRING EYEL	2.000	PC				
Code	Description	Qty	UOM																						
ML1006A0	L21 ED7 DF1 ST STEEL TRACTION SPRING	2.000	PC																						
VM2548A1	PUSH-TO-CLOSE DOOR INT PIPE GUIDE	1.000	PC																						
VM2549A0	SP PUSH-TO-CLOSE DOOR HANDLE SPRING EYEL	2.000	PC																						
VT1222A	557x619x4 SP VITTORIA BLACK EXT GLASS		KVT1222A	VITTORIA BL SPRO EXT BLACK GLASS KIT	<table border="1"> <thead> <tr> <th>Code</th> <th>Description</th> <th>Qty</th> <th>UOM</th> </tr> </thead> <tbody> <tr> <td>0B0388A0</td> <td>SP VITTORIA EXT GLASS SUPPORT PROFILE</td> <td>2.000</td> <td>PC</td> </tr> <tr> <td>SL1187A1</td> <td></td> <td>2.000</td> <td>PC</td> </tr> <tr> <td>VI1220A1</td> <td>4,2x12 TCB SELF-TAPPING SCREW</td> <td>8.000</td> <td>PC</td> </tr> <tr> <td>VT1222A0</td> <td>557x619x4 SP VITTORIA BLACK EXT GLASS</td> <td>1.000</td> <td>PC</td> </tr> </tbody> </table>	Code	Description	Qty	UOM	0B0388A0	SP VITTORIA EXT GLASS SUPPORT PROFILE	2.000	PC	SL1187A1		2.000	PC	VI1220A1	4,2x12 TCB SELF-TAPPING SCREW	8.000	PC	VT1222A0	557x619x4 SP VITTORIA BLACK EXT GLASS	1.000	PC
Code	Description	Qty	UOM																						
0B0388A0	SP VITTORIA EXT GLASS SUPPORT PROFILE	2.000	PC																						
SL1187A1		2.000	PC																						
VI1220A1	4,2x12 TCB SELF-TAPPING SCREW	8.000	PC																						
VT1222A0	557x619x4 SP VITTORIA BLACK EXT GLASS	1.000	PC																						





COMPONENT			SPARE PART																																																																																		
Code	Description	Image	Code	Description	Kit components																																																																																
VT1222A	557x619x4 SP VITTORIA BLACK EXT GLASS		KDR1563A	VITT BLSP G EXT BLACK GLASS DOOR KIT	<table border="1"> <thead> <tr> <th>Code</th> <th>Description</th> <th>Qty</th> <th>UOM</th> </tr> </thead> <tbody> <tr> <td>0B1319A0</td> <td>SP VITTORIA LEFT DOOR RIGHT EXT COLUMN</td> <td>1.000</td> <td>PC</td> </tr> <tr> <td>0B1320A0</td> <td>SP VITTORIA LEFT DOOR RIGHT INT COLUMN</td> <td>1.000</td> <td>PC</td> </tr> <tr> <td>0B1362A0</td> <td>0B1362A0</td> <td>1.000</td> <td>PC</td> </tr> <tr> <td>0B1363A0</td> <td>0B1363A0</td> <td>1.000</td> <td>PC</td> </tr> <tr> <td>ML1005A0</td> <td>DE5 DF0.6 H18 COMPRESSIO N SPRING</td> <td>2.000</td> <td>PC</td> </tr> <tr> <td>SL1187A1</td> <td></td> <td>2.000</td> <td>PC</td> </tr> <tr> <td>TB1563A0</td> <td>DOOR LATERAL BEAM SP800</td> <td>2.000</td> <td>PC</td> </tr> <tr> <td>TB1723A1</td> <td>SHOP.P VITTORIA SLAM DOOR TRANSFER TUBE</td> <td>1.000</td> <td>PC</td> </tr> <tr> <td>TB3305A0</td> <td>SHOP.PRO VITTORIA FLAG DOOR HANDLE TUBE</td> <td>1.000</td> <td>PC</td> </tr> <tr> <td>VI1014A0</td> <td>STAINLESS STEEL WASHER 4.5X9X0.8</td> <td>2.000</td> <td>PC</td> </tr> <tr> <td>VI1024A0</td> <td>SCREW M4x12 TCB + INOX DIN 7985</td> <td>2.000</td> <td>PC</td> </tr> <tr> <td>VI1174A0</td> <td>VI1174A0</td> <td>14.000</td> <td>PC</td> </tr> <tr> <td>VI1220A1</td> <td>4,2x12 TCB SELF-TAPPIN G SCREW</td> <td>18.000</td> <td>PC</td> </tr> <tr> <td>VI1716A0</td> <td>STAINLESS STEEL BLIND THREADED SCREW M4</td> <td>2.000</td> <td>PC</td> </tr> <tr> <td>VI1930A1</td> <td>5x20 ST. STEEL CHIP SCREW</td> <td>10.000</td> <td>PC</td> </tr> <tr> <td>VI1998A0</td> <td>ZINC PLATED SCREW 5X30 TCB</td> <td>2.000</td> <td>PC</td> </tr> <tr> <td>VM1630A1</td> <td>INTERNAL GLASS PUSHING CAP</td> <td>6.000</td> <td>PC</td> </tr> <tr> <td>VM2274A0</td> <td>GROOVED BUSHING</td> <td>1.000</td> <td>PC</td> </tr> <tr> <td>VM2275A0</td> <td>SMOOTH BUSHING</td> <td>1.000</td> <td>PC</td> </tr> </tbody> </table>	Code	Description	Qty	UOM	0B1319A0	SP VITTORIA LEFT DOOR RIGHT EXT COLUMN	1.000	PC	0B1320A0	SP VITTORIA LEFT DOOR RIGHT INT COLUMN	1.000	PC	0B1362A0	0B1362A0	1.000	PC	0B1363A0	0B1363A0	1.000	PC	ML1005A0	DE5 DF0.6 H18 COMPRESSIO N SPRING	2.000	PC	SL1187A1		2.000	PC	TB1563A0	DOOR LATERAL BEAM SP800	2.000	PC	TB1723A1	SHOP.P VITTORIA SLAM DOOR TRANSFER TUBE	1.000	PC	TB3305A0	SHOP.PRO VITTORIA FLAG DOOR HANDLE TUBE	1.000	PC	VI1014A0	STAINLESS STEEL WASHER 4.5X9X0.8	2.000	PC	VI1024A0	SCREW M4x12 TCB + INOX DIN 7985	2.000	PC	VI1174A0	VI1174A0	14.000	PC	VI1220A1	4,2x12 TCB SELF-TAPPIN G SCREW	18.000	PC	VI1716A0	STAINLESS STEEL BLIND THREADED SCREW M4	2.000	PC	VI1930A1	5x20 ST. STEEL CHIP SCREW	10.000	PC	VI1998A0	ZINC PLATED SCREW 5X30 TCB	2.000	PC	VM1630A1	INTERNAL GLASS PUSHING CAP	6.000	PC	VM2274A0	GROOVED BUSHING	1.000	PC	VM2275A0	SMOOTH BUSHING	1.000	PC
Code	Description	Qty	UOM																																																																																		
0B1319A0	SP VITTORIA LEFT DOOR RIGHT EXT COLUMN	1.000	PC																																																																																		
0B1320A0	SP VITTORIA LEFT DOOR RIGHT INT COLUMN	1.000	PC																																																																																		
0B1362A0	0B1362A0	1.000	PC																																																																																		
0B1363A0	0B1363A0	1.000	PC																																																																																		
ML1005A0	DE5 DF0.6 H18 COMPRESSIO N SPRING	2.000	PC																																																																																		
SL1187A1		2.000	PC																																																																																		
TB1563A0	DOOR LATERAL BEAM SP800	2.000	PC																																																																																		
TB1723A1	SHOP.P VITTORIA SLAM DOOR TRANSFER TUBE	1.000	PC																																																																																		
TB3305A0	SHOP.PRO VITTORIA FLAG DOOR HANDLE TUBE	1.000	PC																																																																																		
VI1014A0	STAINLESS STEEL WASHER 4.5X9X0.8	2.000	PC																																																																																		
VI1024A0	SCREW M4x12 TCB + INOX DIN 7985	2.000	PC																																																																																		
VI1174A0	VI1174A0	14.000	PC																																																																																		
VI1220A1	4,2x12 TCB SELF-TAPPIN G SCREW	18.000	PC																																																																																		
VI1716A0	STAINLESS STEEL BLIND THREADED SCREW M4	2.000	PC																																																																																		
VI1930A1	5x20 ST. STEEL CHIP SCREW	10.000	PC																																																																																		
VI1998A0	ZINC PLATED SCREW 5X30 TCB	2.000	PC																																																																																		
VM1630A1	INTERNAL GLASS PUSHING CAP	6.000	PC																																																																																		
VM2274A0	GROOVED BUSHING	1.000	PC																																																																																		
VM2275A0	SMOOTH BUSHING	1.000	PC																																																																																		



COMPONENT			SPARE PART																																																															
Code	Description	Image	Code	Description	Kit components																																																													
VT1222A	557x619x4 SP VITTORIA BLACK EXT GLASS		KDR1563A	VITT BLSP G EXT BLACK GLASS DOOR KIT	<table border="1"> <thead> <tr> <th>Code</th> <th>Description</th> <th>Qty</th> <th>UOM</th> </tr> </thead> <tbody> <tr> <td>VM2456A0</td> <td>BAKERLUX SHOP.PRO HANDLE END</td> <td>2.000</td> <td>PC</td> </tr> <tr> <td>VM2466A0</td> <td>BL SP LEFT LOWER LATERAL DOOR CAP</td> <td>1.000</td> <td>PC</td> </tr> <tr> <td>VM2468A0</td> <td>BL SP LEFT UPPER LATERAL DOOR CAP</td> <td>1.000</td> <td>PC</td> </tr> <tr> <td>VM2470A0</td> <td>SLIDE TO FIX INTERNAL GLASS SHOP.PRO</td> <td>2.000</td> <td>PC</td> </tr> <tr> <td>VM2471A0</td> <td>BL SP LOWER CLAMP INT LOCK GLASS SLIDER</td> <td>1.000</td> <td>PC</td> </tr> <tr> <td>VM2472A0</td> <td>BL SP UPPER CLAMP INT LOCK GLASS SLIDER</td> <td>1.000</td> <td>PC</td> </tr> <tr> <td>VM2473A0</td> <td>BL SP INT GLASS HINGE LOWER LOCK PIN</td> <td>1.000</td> <td>PC</td> </tr> <tr> <td>VM2474A0</td> <td>BL SP INT GLASS HINGE UPPER LOCK PIN</td> <td>1.000</td> <td>PC</td> </tr> <tr> <td>VM2479A0</td> <td>BL SP GLASS H6 PUSHING BRACKET</td> <td>6.000</td> <td>PC</td> </tr> <tr> <td>VM2489A0</td> <td>SP HANDLE END KIT + STYLUS KIT</td> <td>1.000</td> <td>PC</td> </tr> <tr> <td>VM2504A0</td> <td>DOWEL TO GUIDE SLIDE SPRING SHOP.PRO</td> <td>2.000</td> <td>PC</td> </tr> <tr> <td>VM2506A0</td> <td>SP MECH. RIGHT LOWER LATERAL DOOR CAP</td> <td>1.000</td> <td>PC</td> </tr> <tr> <td>VM2507A0</td> <td>SP MECH. RIGHT UPPER LATERAL DOOR CAP</td> <td>1.000</td> <td>PC</td> </tr> <tr> <td>VM2512A0</td> <td>BL SP DOOR-MICRO SWITCH SOFT CLOSING</td> <td>2.000</td> <td>PC</td> </tr> </tbody> </table>	Code	Description	Qty	UOM	VM2456A0	BAKERLUX SHOP.PRO HANDLE END	2.000	PC	VM2466A0	BL SP LEFT LOWER LATERAL DOOR CAP	1.000	PC	VM2468A0	BL SP LEFT UPPER LATERAL DOOR CAP	1.000	PC	VM2470A0	SLIDE TO FIX INTERNAL GLASS SHOP.PRO	2.000	PC	VM2471A0	BL SP LOWER CLAMP INT LOCK GLASS SLIDER	1.000	PC	VM2472A0	BL SP UPPER CLAMP INT LOCK GLASS SLIDER	1.000	PC	VM2473A0	BL SP INT GLASS HINGE LOWER LOCK PIN	1.000	PC	VM2474A0	BL SP INT GLASS HINGE UPPER LOCK PIN	1.000	PC	VM2479A0	BL SP GLASS H6 PUSHING BRACKET	6.000	PC	VM2489A0	SP HANDLE END KIT + STYLUS KIT	1.000	PC	VM2504A0	DOWEL TO GUIDE SLIDE SPRING SHOP.PRO	2.000	PC	VM2506A0	SP MECH. RIGHT LOWER LATERAL DOOR CAP	1.000	PC	VM2507A0	SP MECH. RIGHT UPPER LATERAL DOOR CAP	1.000	PC	VM2512A0	BL SP DOOR-MICRO SWITCH SOFT CLOSING	2.000	PC	
Code	Description	Qty	UOM																																																															
VM2456A0	BAKERLUX SHOP.PRO HANDLE END	2.000	PC																																																															
VM2466A0	BL SP LEFT LOWER LATERAL DOOR CAP	1.000	PC																																																															
VM2468A0	BL SP LEFT UPPER LATERAL DOOR CAP	1.000	PC																																																															
VM2470A0	SLIDE TO FIX INTERNAL GLASS SHOP.PRO	2.000	PC																																																															
VM2471A0	BL SP LOWER CLAMP INT LOCK GLASS SLIDER	1.000	PC																																																															
VM2472A0	BL SP UPPER CLAMP INT LOCK GLASS SLIDER	1.000	PC																																																															
VM2473A0	BL SP INT GLASS HINGE LOWER LOCK PIN	1.000	PC																																																															
VM2474A0	BL SP INT GLASS HINGE UPPER LOCK PIN	1.000	PC																																																															
VM2479A0	BL SP GLASS H6 PUSHING BRACKET	6.000	PC																																																															
VM2489A0	SP HANDLE END KIT + STYLUS KIT	1.000	PC																																																															
VM2504A0	DOWEL TO GUIDE SLIDE SPRING SHOP.PRO	2.000	PC																																																															
VM2506A0	SP MECH. RIGHT LOWER LATERAL DOOR CAP	1.000	PC																																																															
VM2507A0	SP MECH. RIGHT UPPER LATERAL DOOR CAP	1.000	PC																																																															
VM2512A0	BL SP DOOR-MICRO SWITCH SOFT CLOSING	2.000	PC																																																															



COMPONENT			SPARE PART																																																			
Code	Description	Image	Code	Description	Kit components																																																	
VT1222A	557x619x4 SP VITTORIA BLACK EXT GLASS		KDR1563A	VITT BLSP G EXT BLACK GLASS DOOR KIT	<table border="1"> <thead> <tr> <th>Code</th> <th>Description</th> <th>Qty</th> <th>UOM</th> </tr> </thead> <tbody> <tr> <td>VM2527A1</td> <td>EVEREO-S.Pro DISPLAY STYLUS</td> <td>1.000</td> <td>PC</td> </tr> <tr> <td>VM2546A1</td> <td>SP COVER PUSH-TO-CLO SE DOOR HOO</td> <td>1.000</td> <td>PC</td> </tr> <tr> <td>VM2548A1</td> <td>PUSH-TO-CLO SE DOOR INT PIPE GUIDE</td> <td>1.000</td> <td>PC</td> </tr> <tr> <td>VM2549A0</td> <td>SP PUSH-TO-CLO SE DOOR HANDLE SPRING EYEL</td> <td>2.000</td> <td>PC</td> </tr> <tr> <td>VT1222A0</td> <td>557x619x4 SP VITTORIA BLACK EXT GLASS</td> <td>1.000</td> <td>PC</td> </tr> </tbody> </table>	Code	Description	Qty	UOM	VM2527A1	EVEREO-S.Pro DISPLAY STYLUS	1.000	PC	VM2546A1	SP COVER PUSH-TO-CLO SE DOOR HOO	1.000	PC	VM2548A1	PUSH-TO-CLO SE DOOR INT PIPE GUIDE	1.000	PC	VM2549A0	SP PUSH-TO-CLO SE DOOR HANDLE SPRING EYEL	2.000	PC	VT1222A0	557x619x4 SP VITTORIA BLACK EXT GLASS	1.000	PC																									
			Code	Description	Qty	UOM																																																
VM2527A1	EVEREO-S.Pro DISPLAY STYLUS	1.000	PC																																																			
VM2546A1	SP COVER PUSH-TO-CLO SE DOOR HOO	1.000	PC																																																			
VM2548A1	PUSH-TO-CLO SE DOOR INT PIPE GUIDE	1.000	PC																																																			
VM2549A0	SP PUSH-TO-CLO SE DOOR HANDLE SPRING EYEL	2.000	PC																																																			
VT1222A0	557x619x4 SP VITTORIA BLACK EXT GLASS	1.000	PC																																																			
KDR1562A	VITTORIA BLSP G EXT BLACK GLASS DOOR KIT	<table border="1"> <thead> <tr> <th>Code</th> <th>Description</th> <th>Qty</th> <th>UOM</th> </tr> </thead> <tbody> <tr> <td>0B1301A0</td> <td>SP VITTORIA RIGHT DOOR LEFT EXT COLUMN</td> <td>1.000</td> <td>PC</td> </tr> <tr> <td>0B1302A0</td> <td>SP VITTORIA RIGHT DOOR LEFT INT COLUMN</td> <td>1.000</td> <td>PC</td> </tr> <tr> <td>0B1362A0</td> <td>0B1362A0</td> <td>1.000</td> <td>PC</td> </tr> <tr> <td>0B1363A0</td> <td>0B1363A0</td> <td>1.000</td> <td>PC</td> </tr> <tr> <td>ML1005A0</td> <td>DE5 DF0.6 H18 COMPRESSIO N SPRING</td> <td>2.000</td> <td>PC</td> </tr> <tr> <td>SL1187A1</td> <td></td> <td>2.000</td> <td>PC</td> </tr> <tr> <td>TB1563A0</td> <td>DOOR LATERAL BEAM SP800</td> <td>2.000</td> <td>PC</td> </tr> <tr> <td>TB1723A1</td> <td>SHOP.P VITTORIA SLAM DOOR TRANSFER TUBE</td> <td>1.000</td> <td>PC</td> </tr> <tr> <td>TB3305A0</td> <td>SHOP.PRO VITTORIA FLAG DOOR HANDLE TUBE</td> <td>1.000</td> <td>PC</td> </tr> <tr> <td>VI1014A0</td> <td>STAINLESS STEEL WASHER 4.5X9X0.8</td> <td>2.000</td> <td>PC</td> </tr> <tr> <td>VI1024A0</td> <td>SCREW M4x12 TCB + INOX DIN 7985</td> <td>2.000</td> <td>PC</td> </tr> <tr> <td>VI1174A0</td> <td>VI1174A0</td> <td>14.000</td> <td>PC</td> </tr> </tbody> </table>	Code	Description	Qty	UOM	0B1301A0	SP VITTORIA RIGHT DOOR LEFT EXT COLUMN	1.000	PC	0B1302A0	SP VITTORIA RIGHT DOOR LEFT INT COLUMN	1.000	PC	0B1362A0	0B1362A0	1.000	PC	0B1363A0	0B1363A0	1.000	PC	ML1005A0	DE5 DF0.6 H18 COMPRESSIO N SPRING	2.000	PC	SL1187A1		2.000	PC	TB1563A0	DOOR LATERAL BEAM SP800	2.000	PC	TB1723A1	SHOP.P VITTORIA SLAM DOOR TRANSFER TUBE	1.000	PC	TB3305A0	SHOP.PRO VITTORIA FLAG DOOR HANDLE TUBE	1.000	PC	VI1014A0	STAINLESS STEEL WASHER 4.5X9X0.8	2.000	PC	VI1024A0	SCREW M4x12 TCB + INOX DIN 7985	2.000	PC	VI1174A0	VI1174A0	14.000	PC
Code	Description	Qty	UOM																																																			
0B1301A0	SP VITTORIA RIGHT DOOR LEFT EXT COLUMN	1.000	PC																																																			
0B1302A0	SP VITTORIA RIGHT DOOR LEFT INT COLUMN	1.000	PC																																																			
0B1362A0	0B1362A0	1.000	PC																																																			
0B1363A0	0B1363A0	1.000	PC																																																			
ML1005A0	DE5 DF0.6 H18 COMPRESSIO N SPRING	2.000	PC																																																			
SL1187A1		2.000	PC																																																			
TB1563A0	DOOR LATERAL BEAM SP800	2.000	PC																																																			
TB1723A1	SHOP.P VITTORIA SLAM DOOR TRANSFER TUBE	1.000	PC																																																			
TB3305A0	SHOP.PRO VITTORIA FLAG DOOR HANDLE TUBE	1.000	PC																																																			
VI1014A0	STAINLESS STEEL WASHER 4.5X9X0.8	2.000	PC																																																			
VI1024A0	SCREW M4x12 TCB + INOX DIN 7985	2.000	PC																																																			
VI1174A0	VI1174A0	14.000	PC																																																			

COMPONENT			SPARE PART					
Code	Description	Image	Code	Description	Kit components			
VT1222A	557x619x4 SP VITTORIA BLACK EXT GLASS		KDR1562A	VITTORIA BLSP G EXT BLACK GLASS DOOR KIT	Code	Description	Qty	UOM
					VI1220A1	4,2x12 TCB SELF-TAPPIN G SCREW	18.000	PC
					VI1716A0	STAINLESS STEEL BLIND THREADED SCREW M4	2.000	PC
					VI1930A1	5x20 ST. STEEL CHIP SCREW	10.000	PC
					VI1998A0	ZINC PLATED SCREW 5X30 TCB	2.000	PC
					VM1630A1	INTERNAL GLASS PUSHING CAP	6.000	PC
					VM2274A0	GROOVED BUSHING	1.000	PC
					VM2275A0	SMOOTH BUSHING	1.000	PC
					VM2456A0	BAKERLUX SHOP.PRO HANDLE END	2.000	PC
					VM2466A0	BL SP LEFT LOWER LATERAL DOOR CAP	1.000	PC
					VM2468A0	BL SP LEFT UPPER LATERAL DOOR CAP	1.000	PC
					VM2470A0	SLIDE TO FIX INTERNAL GLASS SHOP.PRO	2.000	PC
					VM2471A0	BL SP LOWER CLAMP INT LOCK GLASS SLIDER	1.000	PC
					VM2472A0	BL SP UPPER CLAMP INT LOCK GLASS SLIDER	1.000	PC
					VM2473A0	BL SP INT GLASS HINGE LOWER LOCK PIN	1.000	PC
					VM2474A0	BL SP INT GLASS HINGE UPPER LOCK PIN	1.000	PC
VM2479A0	BL SP GLASS H6 PUSHING BRACKET	6.000	PC					



COMPONENT			SPARE PART																																																																										
Code	Description	Image	Code	Description	Kit components																																																																								
VT1222A	557x619x4 SP VITTORIA BLACK EXT GLASS		KDR1562A	VITTORIA BLSP G EXT BLACK GLASS DOOR KIT	<table border="1"> <thead> <tr> <th>Code</th> <th>Description</th> <th>Qty</th> <th>UOM</th> </tr> </thead> <tbody> <tr> <td>VM2489A0</td> <td>SP HANDLE END KIT + STYLUS KIT</td> <td>1.000</td> <td>PC</td> </tr> <tr> <td>VM2504A0</td> <td>DOWEL TO GUIDE SLIDE SPRING SHOP.PRO</td> <td>2.000</td> <td>PC</td> </tr> <tr> <td>VM2506A0</td> <td>SP MECH. RIGHT LOWER LATERAL DOOR CAP</td> <td>1.000</td> <td>PC</td> </tr> <tr> <td>VM2507A0</td> <td>SP MECH. RIGHT UPPER LATERAL DOOR CAP</td> <td>1.000</td> <td>PC</td> </tr> <tr> <td>VM2512A0</td> <td>BL SP DOOR-MICRO SWITCH SOFT CLOSING</td> <td>2.000</td> <td>PC</td> </tr> <tr> <td>VM2527A1</td> <td>EVEREO-S.Pro DISPLAY STYLUS</td> <td>1.000</td> <td>PC</td> </tr> <tr> <td>VM2546A1</td> <td>SP COVER PUSH-TO-CLO SE DOOR HOO</td> <td>1.000</td> <td>PC</td> </tr> <tr> <td>VM2548A1</td> <td>PUSH-TO-CLO SE DOOR INT PIPE GUIDE</td> <td>1.000</td> <td>PC</td> </tr> <tr> <td>VM2549A0</td> <td>SP PUSH-TO-CLO SE DOOR HANDLE SPRING EYEL</td> <td>2.000</td> <td>PC</td> </tr> <tr> <td>VT1222A0</td> <td>557x619x4 SP VITTORIA BLACK EXT GLASS</td> <td></td> <td></td> <td></td> <td> <table border="1"> <thead> <tr> <th>Code</th> <th>Description</th> <th>Qty</th> <th>UOM</th> </tr> </thead> <tbody> <tr> <td>0B1303B1</td> <td>SP VITTORIA RIGHT DOOR RIGHT EXT COLUMN</td> <td>1.000</td> <td>PC</td> </tr> <tr> <td>0B1304A0</td> <td>SP VITTORIA RIGHT DOOR RIGHT INT COLUMN</td> <td>1.000</td> <td>PC</td> </tr> <tr> <td>0B1319A0</td> <td>SP VITTORIA LEFT DOOR RIGHT EXT COLUMN</td> <td>1.000</td> <td>PC</td> </tr> <tr> <td>0B1320A0</td> <td>SP VITTORIA LEFT DOOR RIGHT INT COLUMN</td> <td>1.000</td> <td>PC</td> </tr> </tbody> </table> </td> </tr> <tr> <td></td> <td></td> <td></td> <td>KDR1493A</td> <td>VITTORIA BLSPTO EXT BLACK GLASS DOOR KIT</td> <td></td> </tr> </tbody> </table>	Code	Description	Qty	UOM	VM2489A0	SP HANDLE END KIT + STYLUS KIT	1.000	PC	VM2504A0	DOWEL TO GUIDE SLIDE SPRING SHOP.PRO	2.000	PC	VM2506A0	SP MECH. RIGHT LOWER LATERAL DOOR CAP	1.000	PC	VM2507A0	SP MECH. RIGHT UPPER LATERAL DOOR CAP	1.000	PC	VM2512A0	BL SP DOOR-MICRO SWITCH SOFT CLOSING	2.000	PC	VM2527A1	EVEREO-S.Pro DISPLAY STYLUS	1.000	PC	VM2546A1	SP COVER PUSH-TO-CLO SE DOOR HOO	1.000	PC	VM2548A1	PUSH-TO-CLO SE DOOR INT PIPE GUIDE	1.000	PC	VM2549A0	SP PUSH-TO-CLO SE DOOR HANDLE SPRING EYEL	2.000	PC	VT1222A0	557x619x4 SP VITTORIA BLACK EXT GLASS				<table border="1"> <thead> <tr> <th>Code</th> <th>Description</th> <th>Qty</th> <th>UOM</th> </tr> </thead> <tbody> <tr> <td>0B1303B1</td> <td>SP VITTORIA RIGHT DOOR RIGHT EXT COLUMN</td> <td>1.000</td> <td>PC</td> </tr> <tr> <td>0B1304A0</td> <td>SP VITTORIA RIGHT DOOR RIGHT INT COLUMN</td> <td>1.000</td> <td>PC</td> </tr> <tr> <td>0B1319A0</td> <td>SP VITTORIA LEFT DOOR RIGHT EXT COLUMN</td> <td>1.000</td> <td>PC</td> </tr> <tr> <td>0B1320A0</td> <td>SP VITTORIA LEFT DOOR RIGHT INT COLUMN</td> <td>1.000</td> <td>PC</td> </tr> </tbody> </table>	Code	Description	Qty	UOM	0B1303B1	SP VITTORIA RIGHT DOOR RIGHT EXT COLUMN	1.000	PC	0B1304A0	SP VITTORIA RIGHT DOOR RIGHT INT COLUMN	1.000	PC	0B1319A0	SP VITTORIA LEFT DOOR RIGHT EXT COLUMN	1.000	PC	0B1320A0	SP VITTORIA LEFT DOOR RIGHT INT COLUMN	1.000	PC				KDR1493A	VITTORIA BLSPTO EXT BLACK GLASS DOOR KIT	
			Code	Description	Qty	UOM																																																																							
VM2489A0	SP HANDLE END KIT + STYLUS KIT	1.000	PC																																																																										
VM2504A0	DOWEL TO GUIDE SLIDE SPRING SHOP.PRO	2.000	PC																																																																										
VM2506A0	SP MECH. RIGHT LOWER LATERAL DOOR CAP	1.000	PC																																																																										
VM2507A0	SP MECH. RIGHT UPPER LATERAL DOOR CAP	1.000	PC																																																																										
VM2512A0	BL SP DOOR-MICRO SWITCH SOFT CLOSING	2.000	PC																																																																										
VM2527A1	EVEREO-S.Pro DISPLAY STYLUS	1.000	PC																																																																										
VM2546A1	SP COVER PUSH-TO-CLO SE DOOR HOO	1.000	PC																																																																										
VM2548A1	PUSH-TO-CLO SE DOOR INT PIPE GUIDE	1.000	PC																																																																										
VM2549A0	SP PUSH-TO-CLO SE DOOR HANDLE SPRING EYEL	2.000	PC																																																																										
VT1222A0	557x619x4 SP VITTORIA BLACK EXT GLASS				<table border="1"> <thead> <tr> <th>Code</th> <th>Description</th> <th>Qty</th> <th>UOM</th> </tr> </thead> <tbody> <tr> <td>0B1303B1</td> <td>SP VITTORIA RIGHT DOOR RIGHT EXT COLUMN</td> <td>1.000</td> <td>PC</td> </tr> <tr> <td>0B1304A0</td> <td>SP VITTORIA RIGHT DOOR RIGHT INT COLUMN</td> <td>1.000</td> <td>PC</td> </tr> <tr> <td>0B1319A0</td> <td>SP VITTORIA LEFT DOOR RIGHT EXT COLUMN</td> <td>1.000</td> <td>PC</td> </tr> <tr> <td>0B1320A0</td> <td>SP VITTORIA LEFT DOOR RIGHT INT COLUMN</td> <td>1.000</td> <td>PC</td> </tr> </tbody> </table>	Code	Description	Qty	UOM	0B1303B1	SP VITTORIA RIGHT DOOR RIGHT EXT COLUMN	1.000	PC	0B1304A0	SP VITTORIA RIGHT DOOR RIGHT INT COLUMN	1.000	PC	0B1319A0	SP VITTORIA LEFT DOOR RIGHT EXT COLUMN	1.000	PC	0B1320A0	SP VITTORIA LEFT DOOR RIGHT INT COLUMN	1.000	PC																																																				
Code	Description	Qty	UOM																																																																										
0B1303B1	SP VITTORIA RIGHT DOOR RIGHT EXT COLUMN	1.000	PC																																																																										
0B1304A0	SP VITTORIA RIGHT DOOR RIGHT INT COLUMN	1.000	PC																																																																										
0B1319A0	SP VITTORIA LEFT DOOR RIGHT EXT COLUMN	1.000	PC																																																																										
0B1320A0	SP VITTORIA LEFT DOOR RIGHT INT COLUMN	1.000	PC																																																																										
			KDR1493A	VITTORIA BLSPTO EXT BLACK GLASS DOOR KIT																																																																									



COMPONENT			SPARE PART																																																																														
Code	Description	Image	Code	Description	Kit components																																																																												
VT1222A	557x619x4 SP VITTORIA BLACK EXT GLASS		KDR1493A	VITTORIA BLSPTO EXT BLACK GLASS DOOR KIT	<table border="1"> <thead> <tr> <th>Code</th> <th>Description</th> <th>Qty</th> <th>UOM</th> </tr> </thead> <tbody> <tr> <td>0H10283A0</td> <td></td> <td>1.000</td> <td>PC</td> </tr> <tr> <td>CR1040A0</td> <td>DOOR LATCH FOR EL.MECH. LOCKING SYSTEM</td> <td>1.000</td> <td>PC</td> </tr> <tr> <td>ML1005A0</td> <td>DES DF0.6 H18 COMPRESSIO N SPRING</td> <td>2.000</td> <td>PC</td> </tr> <tr> <td>SL1187A2</td> <td></td> <td>2.000</td> <td>PC</td> </tr> <tr> <td>TB1563A0</td> <td>DOOR LATERAL BEAM SP800</td> <td>2.000</td> <td>PC</td> </tr> <tr> <td>TB3305A0</td> <td>SHOP.PRO VITTORIA FLAG DOOR HANDLE TUBE</td> <td>1.000</td> <td>PC</td> </tr> <tr> <td>VI1036A0</td> <td>ST STEEL STRIPED THREAD M10 FTT/C INSERT</td> <td>1.000</td> <td>PC</td> </tr> <tr> <td>VI1174A0</td> <td>VI1174A0</td> <td>10.000</td> <td>PC</td> </tr> <tr> <td>VI1220A1</td> <td>4,2x12 TCB SELF-TAPPIN G SCREW</td> <td>18.000</td> <td>PC</td> </tr> <tr> <td>VI1930A1</td> <td>5x20 ST. STEEL CHIP SCREW</td> <td>10.000</td> <td>PC</td> </tr> <tr> <td>VI1998A0</td> <td>ZINC PLATED SCREW 5X30 TCB</td> <td>2.000</td> <td>PC</td> </tr> <tr> <td>VM1209A0</td> <td>SHOP.PRO LOCK PIN WASHER</td> <td>1.000</td> <td>PC</td> </tr> <tr> <td>VM1630A1</td> <td>INTERNAL GLASS PUSHING CAP</td> <td>6.000</td> <td>PC</td> </tr> <tr> <td>VM2274A0</td> <td>GROOVED BUSHING</td> <td>1.000</td> <td>PC</td> </tr> <tr> <td>VM2275A0</td> <td>SMOOTH BUSHING</td> <td>1.000</td> <td>PC</td> </tr> <tr> <td>VM2456A0</td> <td>BAKERLUX SHOP.PRO HANDLE END</td> <td>2.000</td> <td>PC</td> </tr> <tr> <td>VM2465A0</td> <td>SP SIDE-OPENIN G DOOR RIGHT LOWER CAP KIT</td> <td>1.000</td> <td>PC</td> </tr> <tr> <td>VM2466A0</td> <td>BL SP LEFT LOWER LATERAL DOOR CAP</td> <td>1.000</td> <td>PC</td> </tr> </tbody> </table>	Code	Description	Qty	UOM	0H10283A0		1.000	PC	CR1040A0	DOOR LATCH FOR EL.MECH. LOCKING SYSTEM	1.000	PC	ML1005A0	DES DF0.6 H18 COMPRESSIO N SPRING	2.000	PC	SL1187A2		2.000	PC	TB1563A0	DOOR LATERAL BEAM SP800	2.000	PC	TB3305A0	SHOP.PRO VITTORIA FLAG DOOR HANDLE TUBE	1.000	PC	VI1036A0	ST STEEL STRIPED THREAD M10 FTT/C INSERT	1.000	PC	VI1174A0	VI1174A0	10.000	PC	VI1220A1	4,2x12 TCB SELF-TAPPIN G SCREW	18.000	PC	VI1930A1	5x20 ST. STEEL CHIP SCREW	10.000	PC	VI1998A0	ZINC PLATED SCREW 5X30 TCB	2.000	PC	VM1209A0	SHOP.PRO LOCK PIN WASHER	1.000	PC	VM1630A1	INTERNAL GLASS PUSHING CAP	6.000	PC	VM2274A0	GROOVED BUSHING	1.000	PC	VM2275A0	SMOOTH BUSHING	1.000	PC	VM2456A0	BAKERLUX SHOP.PRO HANDLE END	2.000	PC	VM2465A0	SP SIDE-OPENIN G DOOR RIGHT LOWER CAP KIT	1.000	PC	VM2466A0	BL SP LEFT LOWER LATERAL DOOR CAP	1.000	PC
					Code	Description	Qty	UOM																																																																									
					0H10283A0		1.000	PC																																																																									
					CR1040A0	DOOR LATCH FOR EL.MECH. LOCKING SYSTEM	1.000	PC																																																																									
					ML1005A0	DES DF0.6 H18 COMPRESSIO N SPRING	2.000	PC																																																																									
					SL1187A2		2.000	PC																																																																									
					TB1563A0	DOOR LATERAL BEAM SP800	2.000	PC																																																																									
					TB3305A0	SHOP.PRO VITTORIA FLAG DOOR HANDLE TUBE	1.000	PC																																																																									
					VI1036A0	ST STEEL STRIPED THREAD M10 FTT/C INSERT	1.000	PC																																																																									
					VI1174A0	VI1174A0	10.000	PC																																																																									
					VI1220A1	4,2x12 TCB SELF-TAPPIN G SCREW	18.000	PC																																																																									
					VI1930A1	5x20 ST. STEEL CHIP SCREW	10.000	PC																																																																									
					VI1998A0	ZINC PLATED SCREW 5X30 TCB	2.000	PC																																																																									
					VM1209A0	SHOP.PRO LOCK PIN WASHER	1.000	PC																																																																									
					VM1630A1	INTERNAL GLASS PUSHING CAP	6.000	PC																																																																									
					VM2274A0	GROOVED BUSHING	1.000	PC																																																																									
					VM2275A0	SMOOTH BUSHING	1.000	PC																																																																									
					VM2456A0	BAKERLUX SHOP.PRO HANDLE END	2.000	PC																																																																									
					VM2465A0	SP SIDE-OPENIN G DOOR RIGHT LOWER CAP KIT	1.000	PC																																																																									
					VM2466A0	BL SP LEFT LOWER LATERAL DOOR CAP	1.000	PC																																																																									



COMPONENT			SPARE PART																																																																	
Code	Description	Image	Code	Description	Kit components																																																															
VT1222A	557x619x4 SP VITTORIA BLACK EXT GLASS		KDR1493A	VITTORIA BLSPTO EXT BLACK GLASS DOOR KIT	<table border="1"> <thead> <tr> <th>Code</th> <th>Description</th> <th>Qty</th> <th>UOM</th> </tr> </thead> <tbody> <tr> <td>VM2467A0</td> <td>SP SIDE-OPENING DOOR RIGHT UPPER CAP KIT</td> <td>1.000</td> <td>PC</td> </tr> <tr> <td>VM2468A0</td> <td>BL SP LEFT UPPER LATERAL DOOR CAP</td> <td>1.000</td> <td>PC</td> </tr> <tr> <td>VM2470A0</td> <td>SLIDE TO FIX INTERNAL GLASS SHOP.PRO</td> <td>2.000</td> <td>PC</td> </tr> <tr> <td>VM2471A0</td> <td>BL SP LOWER CLAMP INT LOCK GLASS SLIDER</td> <td>1.000</td> <td>PC</td> </tr> <tr> <td>VM2472A0</td> <td>BL SP UPPER CLAMP INT LOCK GLASS SLIDER</td> <td>1.000</td> <td>PC</td> </tr> <tr> <td>VM2473A0</td> <td>BL SP INT GLASS HINGE LOWER LOCK PIN</td> <td>1.000</td> <td>PC</td> </tr> <tr> <td>VM2474A0</td> <td>BL SP INT GLASS HINGE UPPER LOCK PIN</td> <td>1.000</td> <td>PC</td> </tr> <tr> <td>VM2479A0</td> <td>BL SP GLASS H6 PUSHING BRACKET</td> <td>6.000</td> <td>PC</td> </tr> <tr> <td>VM2489A0</td> <td>SP HANDLE END KIT + STYLUS KIT</td> <td>1.000</td> <td>PC</td> </tr> <tr> <td>VM2504A0</td> <td>DOWEL TO GUIDE SLIDE SPRING SHOP.PRO</td> <td>2.000</td> <td>PC</td> </tr> <tr> <td>VM2527A1</td> <td>EVEREO-S.Pro DISPLAY STYLUS</td> <td>1.000</td> <td>PC</td> </tr> <tr> <td>VT1222A0</td> <td>557x619x4 SP VITTORIA BLACK EXT GLASS</td> <td>1.000</td> <td>PC</td> </tr> </tbody> </table>	Code	Description	Qty	UOM	VM2467A0	SP SIDE-OPENING DOOR RIGHT UPPER CAP KIT	1.000	PC	VM2468A0	BL SP LEFT UPPER LATERAL DOOR CAP	1.000	PC	VM2470A0	SLIDE TO FIX INTERNAL GLASS SHOP.PRO	2.000	PC	VM2471A0	BL SP LOWER CLAMP INT LOCK GLASS SLIDER	1.000	PC	VM2472A0	BL SP UPPER CLAMP INT LOCK GLASS SLIDER	1.000	PC	VM2473A0	BL SP INT GLASS HINGE LOWER LOCK PIN	1.000	PC	VM2474A0	BL SP INT GLASS HINGE UPPER LOCK PIN	1.000	PC	VM2479A0	BL SP GLASS H6 PUSHING BRACKET	6.000	PC	VM2489A0	SP HANDLE END KIT + STYLUS KIT	1.000	PC	VM2504A0	DOWEL TO GUIDE SLIDE SPRING SHOP.PRO	2.000	PC	VM2527A1	EVEREO-S.Pro DISPLAY STYLUS	1.000	PC	VT1222A0	557x619x4 SP VITTORIA BLACK EXT GLASS	1.000	PC	KDR1492A	VITTORIA BLSP T EXT BLACK GLASS DOOR KIT	<table border="1"> <thead> <tr> <th>Code</th> <th>Description</th> <th>Qty</th> <th>UOM</th> </tr> </thead> <tbody> <tr> <td>0B1301A0</td> <td>SP VITTORIA RIGHT DOOR LEFT EXT COLUMN</td> <td>1.000</td> <td>PC</td> </tr> </tbody> </table>	Code	Description	Qty	UOM	0B1301A0	SP VITTORIA RIGHT DOOR LEFT EXT COLUMN	1.000	PC
			Code	Description	Qty	UOM																																																														
VM2467A0	SP SIDE-OPENING DOOR RIGHT UPPER CAP KIT	1.000	PC																																																																	
VM2468A0	BL SP LEFT UPPER LATERAL DOOR CAP	1.000	PC																																																																	
VM2470A0	SLIDE TO FIX INTERNAL GLASS SHOP.PRO	2.000	PC																																																																	
VM2471A0	BL SP LOWER CLAMP INT LOCK GLASS SLIDER	1.000	PC																																																																	
VM2472A0	BL SP UPPER CLAMP INT LOCK GLASS SLIDER	1.000	PC																																																																	
VM2473A0	BL SP INT GLASS HINGE LOWER LOCK PIN	1.000	PC																																																																	
VM2474A0	BL SP INT GLASS HINGE UPPER LOCK PIN	1.000	PC																																																																	
VM2479A0	BL SP GLASS H6 PUSHING BRACKET	6.000	PC																																																																	
VM2489A0	SP HANDLE END KIT + STYLUS KIT	1.000	PC																																																																	
VM2504A0	DOWEL TO GUIDE SLIDE SPRING SHOP.PRO	2.000	PC																																																																	
VM2527A1	EVEREO-S.Pro DISPLAY STYLUS	1.000	PC																																																																	
VT1222A0	557x619x4 SP VITTORIA BLACK EXT GLASS	1.000	PC																																																																	
Code	Description	Qty	UOM																																																																	
0B1301A0	SP VITTORIA RIGHT DOOR LEFT EXT COLUMN	1.000	PC																																																																	



COMPONENT			SPARE PART					
Code	Description	Image	Code	Description	Kit components			
VT1222A	557x619x4 SP VITTORIA BLACK EXT GLASS		KDR1492A	VITTORIA BLS P T EXT BLACK GLASS DOOR KIT	Code	Description	Qty	UOM
					0B1302A0	SP VITTORIA RIGHT DOOR LEFT INT COLUMN	1.000	PC
					0B1303B1	SP VITTORIA RIGHT DOOR RIGHT EXT COLUMN	1.000	PC
					0B1304A0	SP VITTORIA RIGHT DOOR RIGHT INT COLUMN	1.000	PC
					0H10283A0		1.000	PC
					CR1040A0	DOOR LATCH FOR EL.MECH. LOCKING SYSTEM	1.000	PC
					ML1005A0	DES DF0.6 H18 COMPRESSIO N SPRING	2.000	PC
					SL1187A2		2.000	PC
					TB1563A0	DOOR LATERAL BEAM SP800	2.000	PC
					TB3305A0	SHOP.PRO VITTORIA FLAG DOOR HANDLE TUBE	1.000	PC
					VI1036A0	ST STEEL STRIPED THREAD M10 FTT/C INSERT	1.000	PC
					VI1174A0	VI1174A0	10.000	PC
					VI1220A1	4,2x12 TCB SELF-TAPPIN G SCREW	18.000	PC
					VI1930A1	5x20 ST. STEEL CHIP SCREW	10.000	PC
					VI1998A0	ZINC PLATED SCREW 5X30 TCB	2.000	PC
					VM1209A0	SHOP.PRO LOCK PIN WASHER	1.000	PC
					VM1630A1	INTERNAL GLASS PUSHING CAP	6.000	PC
					VM2274A0	GROOVED BUSHING	1.000	PC
					VM2275A0	SMOOTH BUSHING	1.000	PC
					VM2456A0	BAKERLUX SHOP.PRO HANDLE END	2.000	PC



COMPONENT			SPARE PART																																																																
Code	Description	Image	Code	Description	Kit components																																																														
VT1222A	557x619x4 SP VITTORIA BLACK EXT GLASS		KDR1492A	VITTORIA BLSP T EXT BLACK GLASS DOOR KIT	<table border="1"> <thead> <tr> <th>Code</th> <th>Description</th> <th>Qty</th> <th>UOM</th> </tr> </thead> <tbody> <tr> <td>VM2465A0</td> <td>SP SIDE-OPENIN G DOOR RIGHT LOWER CAP KIT</td> <td>1.000</td> <td>PC</td> </tr> <tr> <td>VM2466A0</td> <td>BL SP LEFT LOWER LATERAL DOOR CAP</td> <td>1.000</td> <td>PC</td> </tr> <tr> <td>VM2467A0</td> <td>SP SIDE-OPENIN G DOOR RIGHT UPPER CAP KIT</td> <td>1.000</td> <td>PC</td> </tr> <tr> <td>VM2468A0</td> <td>BL SP LEFT UPPER LATERAL DOOR CAP</td> <td>1.000</td> <td>PC</td> </tr> <tr> <td>VM2470A0</td> <td>SLIDE TO FIX INTERNAL GLASS SHOP.PRO</td> <td>2.000</td> <td>PC</td> </tr> <tr> <td>VM2471A0</td> <td>BL SP LOWER CLAMP INT LOCK GLASS SLIDER</td> <td>1.000</td> <td>PC</td> </tr> <tr> <td>VM2472A0</td> <td>BL SP UPPER CLAMP INT LOCK GLASS SLIDER</td> <td>1.000</td> <td>PC</td> </tr> <tr> <td>VM2473A0</td> <td>BL SP INT GLASS HINGE LOWER LOCK PIN</td> <td>1.000</td> <td>PC</td> </tr> <tr> <td>VM2474A0</td> <td>BL SP INT GLASS HINGE UPPER LOCK PIN</td> <td>1.000</td> <td>PC</td> </tr> <tr> <td>VM2479A0</td> <td>BL SP GLASS H6 PUSHING BRACKET</td> <td>6.000</td> <td>PC</td> </tr> <tr> <td>VM2489A0</td> <td>SP HANDLE END KIT + STYLUS KIT</td> <td>1.000</td> <td>PC</td> </tr> <tr> <td>VM2504A0</td> <td>DOWEL TO GUIDE SLIDE SPRING SHOP.PRO</td> <td>2.000</td> <td>PC</td> </tr> <tr> <td>VM2527A1</td> <td>EVEREO-S.Pro DISPLAY STYLUS</td> <td>1.000</td> <td>PC</td> </tr> <tr> <td>VT1222A0</td> <td>557x619x4 SP VITTORIA BLACK EXT GLASS</td> <td></td> <td></td> <td></td> <td>1.000 PC</td> </tr> </tbody> </table>	Code	Description	Qty	UOM	VM2465A0	SP SIDE-OPENIN G DOOR RIGHT LOWER CAP KIT	1.000	PC	VM2466A0	BL SP LEFT LOWER LATERAL DOOR CAP	1.000	PC	VM2467A0	SP SIDE-OPENIN G DOOR RIGHT UPPER CAP KIT	1.000	PC	VM2468A0	BL SP LEFT UPPER LATERAL DOOR CAP	1.000	PC	VM2470A0	SLIDE TO FIX INTERNAL GLASS SHOP.PRO	2.000	PC	VM2471A0	BL SP LOWER CLAMP INT LOCK GLASS SLIDER	1.000	PC	VM2472A0	BL SP UPPER CLAMP INT LOCK GLASS SLIDER	1.000	PC	VM2473A0	BL SP INT GLASS HINGE LOWER LOCK PIN	1.000	PC	VM2474A0	BL SP INT GLASS HINGE UPPER LOCK PIN	1.000	PC	VM2479A0	BL SP GLASS H6 PUSHING BRACKET	6.000	PC	VM2489A0	SP HANDLE END KIT + STYLUS KIT	1.000	PC	VM2504A0	DOWEL TO GUIDE SLIDE SPRING SHOP.PRO	2.000	PC	VM2527A1	EVEREO-S.Pro DISPLAY STYLUS	1.000	PC	VT1222A0	557x619x4 SP VITTORIA BLACK EXT GLASS				1.000 PC
Code	Description	Qty	UOM																																																																
VM2465A0	SP SIDE-OPENIN G DOOR RIGHT LOWER CAP KIT	1.000	PC																																																																
VM2466A0	BL SP LEFT LOWER LATERAL DOOR CAP	1.000	PC																																																																
VM2467A0	SP SIDE-OPENIN G DOOR RIGHT UPPER CAP KIT	1.000	PC																																																																
VM2468A0	BL SP LEFT UPPER LATERAL DOOR CAP	1.000	PC																																																																
VM2470A0	SLIDE TO FIX INTERNAL GLASS SHOP.PRO	2.000	PC																																																																
VM2471A0	BL SP LOWER CLAMP INT LOCK GLASS SLIDER	1.000	PC																																																																
VM2472A0	BL SP UPPER CLAMP INT LOCK GLASS SLIDER	1.000	PC																																																																
VM2473A0	BL SP INT GLASS HINGE LOWER LOCK PIN	1.000	PC																																																																
VM2474A0	BL SP INT GLASS HINGE UPPER LOCK PIN	1.000	PC																																																																
VM2479A0	BL SP GLASS H6 PUSHING BRACKET	6.000	PC																																																																
VM2489A0	SP HANDLE END KIT + STYLUS KIT	1.000	PC																																																																
VM2504A0	DOWEL TO GUIDE SLIDE SPRING SHOP.PRO	2.000	PC																																																																
VM2527A1	EVEREO-S.Pro DISPLAY STYLUS	1.000	PC																																																																
VT1222A0	557x619x4 SP VITTORIA BLACK EXT GLASS				1.000 PC																																																														



COMPONENT			SPARE PART																															
Code	Description	Image	Code	Description	Kit components																													
VT1348A	SP VITTORIA INNER GLASS WITH HINGE		KVT1348A	BLSP VITTORIA COMPLETE INT. GLASS KIT	<table border="1"> <thead> <tr> <th>Code</th> <th>Description</th> <th>Qty</th> <th>UOM</th> </tr> </thead> <tbody> <tr> <td>CR1103A0</td> <td>INTERNAL GLASS ST. STEEL UPPER HINGE</td> <td>1.000</td> <td>PC</td> </tr> <tr> <td>CR1104A0</td> <td>INTERNAL GLASS ST. STEEL LOWER HINGE</td> <td>1.000</td> <td>PC</td> </tr> <tr> <td>VI1810A0</td> <td>M6X6 STAINLESS STEEL FLATHEAD SCREW</td> <td>6.000</td> <td>PC</td> </tr> <tr> <td>VM2399A0</td> <td>DOOR HINGES HEADLESS SCREWS COVER</td> <td>2.000</td> <td>PC</td> </tr> <tr> <td>VM2476A0</td> <td>BL SP H6 INTERNAL GLASS HINGE GASKET</td> <td>2.000</td> <td>PC</td> </tr> <tr> <td>VT1333A1</td> <td>SP VITTORIA 718x573.5x6 INNER GLASS</td> <td>1.000</td> <td>PC</td> </tr> </tbody> </table>		Code	Description	Qty	UOM	CR1103A0	INTERNAL GLASS ST. STEEL UPPER HINGE	1.000	PC	CR1104A0	INTERNAL GLASS ST. STEEL LOWER HINGE	1.000	PC	VI1810A0	M6X6 STAINLESS STEEL FLATHEAD SCREW	6.000	PC	VM2399A0	DOOR HINGES HEADLESS SCREWS COVER	2.000	PC	VM2476A0	BL SP H6 INTERNAL GLASS HINGE GASKET	2.000	PC	VT1333A1	SP VITTORIA 718x573.5x6 INNER GLASS	1.000	PC
Code	Description	Qty	UOM																															
CR1103A0	INTERNAL GLASS ST. STEEL UPPER HINGE	1.000	PC																															
CR1104A0	INTERNAL GLASS ST. STEEL LOWER HINGE	1.000	PC																															
VI1810A0	M6X6 STAINLESS STEEL FLATHEAD SCREW	6.000	PC																															
VM2399A0	DOOR HINGES HEADLESS SCREWS COVER	2.000	PC																															
VM2476A0	BL SP H6 INTERNAL GLASS HINGE GASKET	2.000	PC																															
VT1333A1	SP VITTORIA 718x573.5x6 INNER GLASS	1.000	PC																															

ASM8227A/0.D00 - Electrical system - FRONT

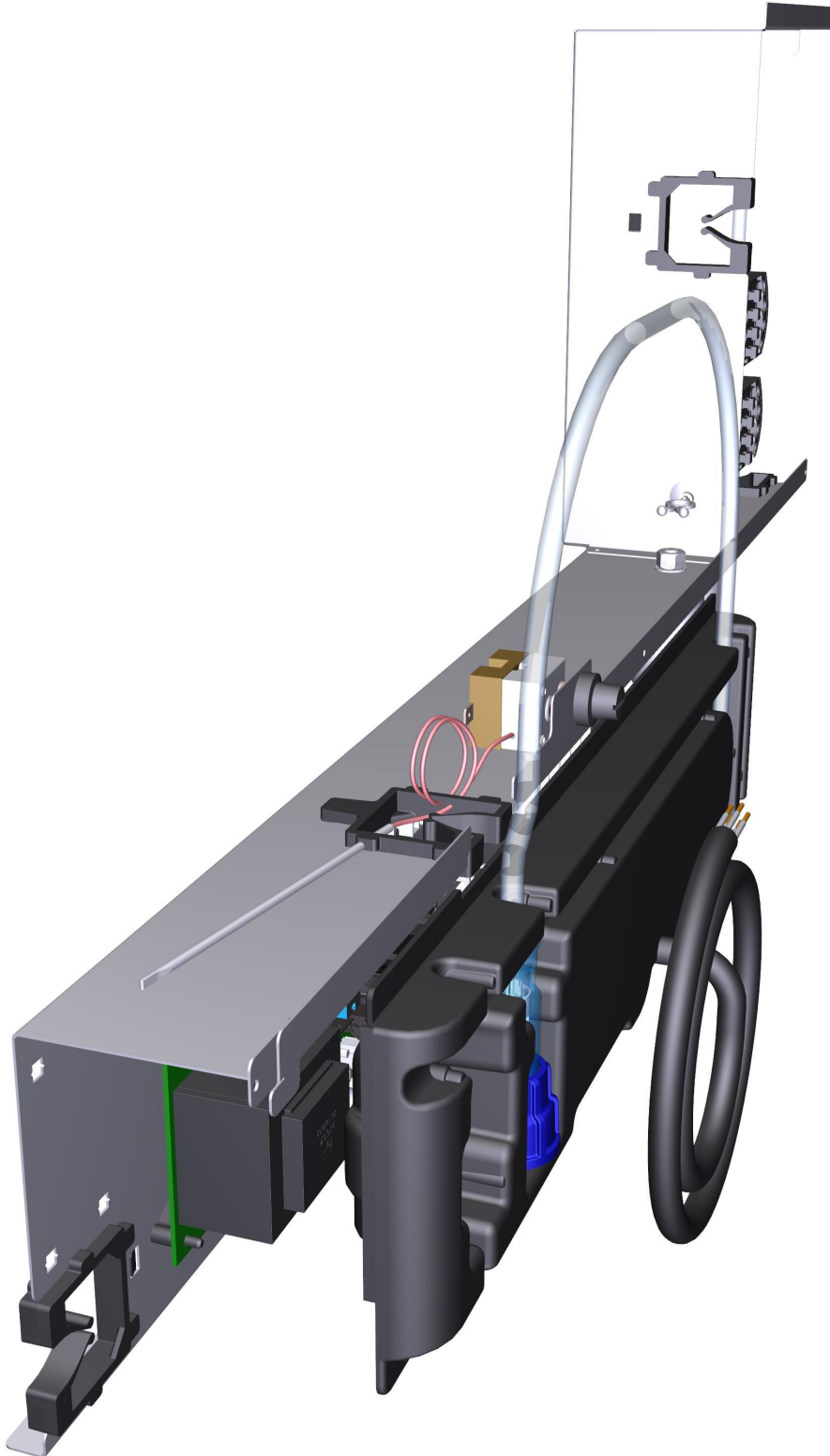



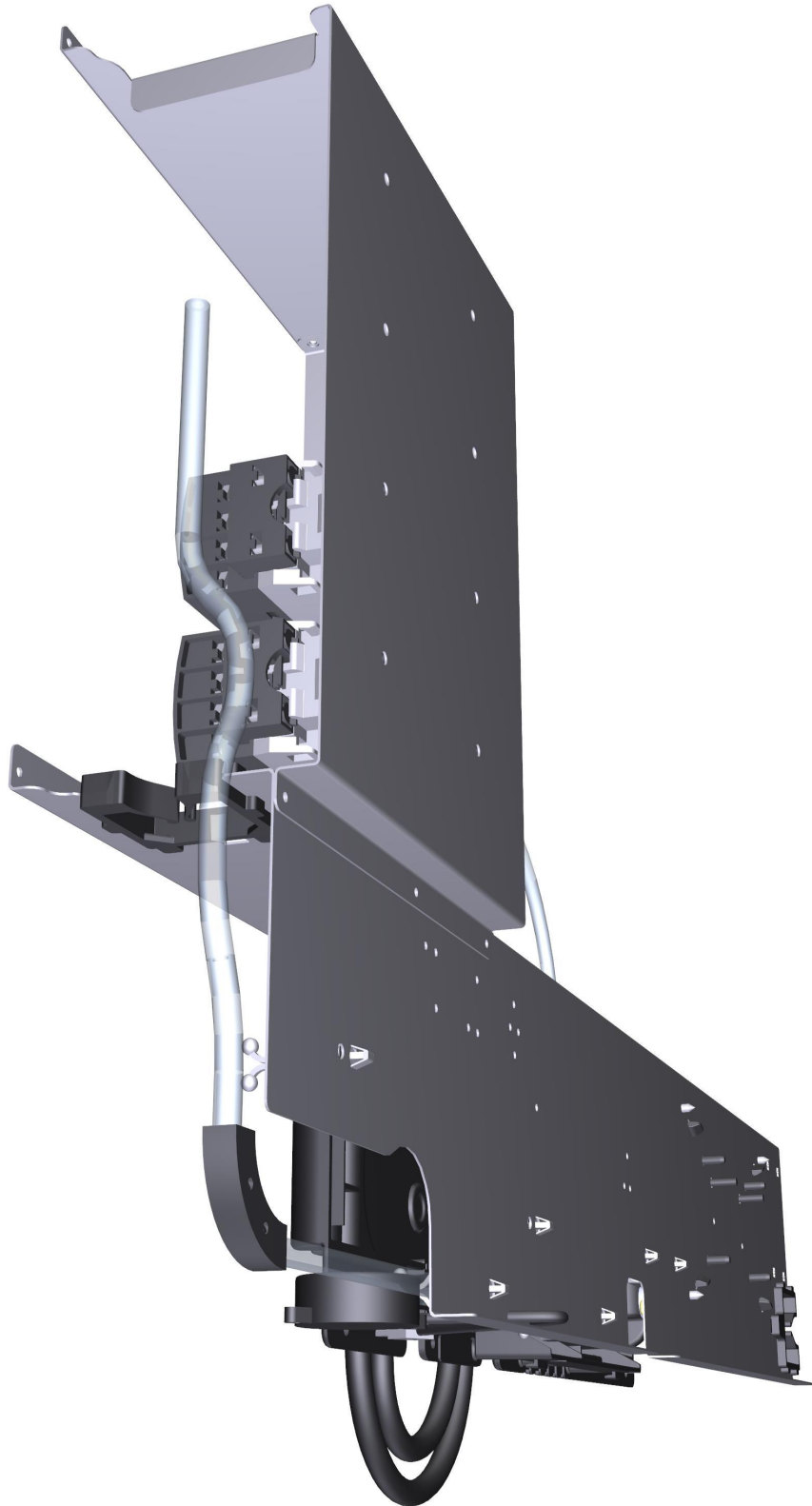

ASM8227A/0.D00 - Electrical system - REAR







COMPONENT			SPARE PART																														
Code	Description	Image	Code	Description	Kit components																												
0P1023B	SP VIT-CAM EL COMPONENTS HOLDER		0P1023B0	SP VIT-CAM EL COMPONENTS HOLDER																													
0P1024B	CONTACTOR HOLDER VIT-CAM S		0P1024B0	CONTACTOR HOLDER VIT-CAM S																													
VI1034A	STAINLESS STEEL WASHER 8.4x16x1		KVI1034A	STAINLESS STEEL WASHER 10 PCS KIT	<table border="1"> <thead> <tr> <th>Code</th> <th>Description</th> <th>Qty</th> <th>UOM</th> </tr> </thead> <tbody> <tr> <td>VI1034A0</td> <td>STAINLESS STEEL WASHER 8.4x16x1</td> <td>10.000</td> <td>PC</td> </tr> </tbody> </table>	Code	Description	Qty	UOM	VI1034A0	STAINLESS STEEL WASHER 8.4x16x1	10.000	PC																				
Code	Description	Qty	UOM																														
VI1034A0	STAINLESS STEEL WASHER 8.4x16x1	10.000	PC																														
VL1145A	VL1145A1		KVL1145A	3/4-JG8 FITTING WITH FILTER AND NRV KIT	<table border="1"> <thead> <tr> <th>Code</th> <th>Description</th> <th>Qty</th> <th>UOM</th> </tr> </thead> <tbody> <tr> <td>VL1145A1</td> <td>VL1145A1</td> <td>1.000</td> <td>PC</td> </tr> </tbody> </table>	Code	Description	Qty	UOM	VL1145A1	VL1145A1	1.000	PC																				
Code	Description	Qty	UOM																														
VL1145A1	VL1145A1	1.000	PC																														
VE2000A	50/60HZ 230V 30A 4P CONTACTOR		KVE2000A	50/60HZ 230V 30A 4P CONTACTOR KIT	<table border="1"> <thead> <tr> <th>Code</th> <th>Description</th> <th>Qty</th> <th>UOM</th> </tr> </thead> <tbody> <tr> <td>CE1455A0</td> <td>TIP END FITTING</td> <td>2.000</td> <td>PC</td> </tr> <tr> <td>CE1560A0</td> <td>BALCK UNIP AWG18 ST.3135 WIRE</td> <td>0.250</td> <td>M</td> </tr> <tr> <td>VE2000A0</td> <td>50/60HZ 230V 30A 4P CONTACTOR</td> <td>1.000</td> <td>PC</td> </tr> <tr> <td>VI1220A1</td> <td>4,2x12 TCB SELF-TAPPIN G SCREW</td> <td>2.000</td> <td>PC</td> </tr> <tr> <td>VM1075A1</td> <td>PLASTIC CLIP TO FIX CONTACTORS</td> <td>4.000</td> <td>PC</td> </tr> <tr> <td>VM2191A1</td> <td>VE1095 CONTACTOR BRACKET</td> <td>1.000</td> <td>PC</td> </tr> </tbody> </table>	Code	Description	Qty	UOM	CE1455A0	TIP END FITTING	2.000	PC	CE1560A0	BALCK UNIP AWG18 ST.3135 WIRE	0.250	M	VE2000A0	50/60HZ 230V 30A 4P CONTACTOR	1.000	PC	VI1220A1	4,2x12 TCB SELF-TAPPIN G SCREW	2.000	PC	VM1075A1	PLASTIC CLIP TO FIX CONTACTORS	4.000	PC	VM2191A1	VE1095 CONTACTOR BRACKET	1.000	PC
Code	Description	Qty	UOM																														
CE1455A0	TIP END FITTING	2.000	PC																														
CE1560A0	BALCK UNIP AWG18 ST.3135 WIRE	0.250	M																														
VE2000A0	50/60HZ 230V 30A 4P CONTACTOR	1.000	PC																														
VI1220A1	4,2x12 TCB SELF-TAPPIN G SCREW	2.000	PC																														
VM1075A1	PLASTIC CLIP TO FIX CONTACTORS	4.000	PC																														
VM2191A1	VE1095 CONTACTOR BRACKET	1.000	PC																														

COMPONENT			SPARE PART																										
Code	Description	Image	Code	Description	Kit components																								
VM2191A	VE1095 CONTACTOR BRACKET		VM2191A1	VE1095 CONTACTOR BRACKET																									
PE2260A	BL SHOP.PRO 230V POWER BOARD		KPE2260A	BL SHOP.PRO 230V POWER CARD KIT	<table border="1"> <thead> <tr> <th>Code</th> <th>Description</th> <th>Qty</th> <th>UOM</th> </tr> </thead> <tbody> <tr> <td>PE2260A1</td> <td>BL SHOP.PRO 230V POWER BOARD</td> <td>1.000</td> <td>PC</td> </tr> <tr> <td>VI1988A0</td> <td>AUTOTHREAD ING SCREW 4,2x19 TCB+ INOX</td> <td>3.000</td> <td>PC</td> </tr> <tr> <td>VM1187A0</td> <td>POWER BOARD FRAME SHOP.PRO</td> <td>1.000</td> <td>PC</td> </tr> <tr> <td>VM1447A0</td> <td></td> <td>1.000</td> <td>PC</td> </tr> <tr> <td>VM1748A0</td> <td>JOINT-JOINT H10 BOARD FIXING CLIP</td> <td>6.000</td> <td>PC</td> </tr> </tbody> </table>	Code	Description	Qty	UOM	PE2260A1	BL SHOP.PRO 230V POWER BOARD	1.000	PC	VI1988A0	AUTOTHREAD ING SCREW 4,2x19 TCB+ INOX	3.000	PC	VM1187A0	POWER BOARD FRAME SHOP.PRO	1.000	PC	VM1447A0		1.000	PC	VM1748A0	JOINT-JOINT H10 BOARD FIXING CLIP	6.000	PC
Code	Description	Qty	UOM																										
PE2260A1	BL SHOP.PRO 230V POWER BOARD	1.000	PC																										
VI1988A0	AUTOTHREAD ING SCREW 4,2x19 TCB+ INOX	3.000	PC																										
VM1187A0	POWER BOARD FRAME SHOP.PRO	1.000	PC																										
VM1447A0		1.000	PC																										
VM1748A0	JOINT-JOINT H10 BOARD FIXING CLIP	6.000	PC																										
VM1187A	POWER BOARD FRAME SHOP.PRO		VM1187A0	POWER BOARD FRAME SHOP.PRO																									
CN1003A	6,3 Uf MOTOR CAPACITOR		KCN1003A	6,3 uF MOTOR CAPACITOR KIT	<table border="1"> <thead> <tr> <th>Code</th> <th>Description</th> <th>Qty</th> <th>UOM</th> </tr> </thead> <tbody> <tr> <td>CN1003A0</td> <td>6,3 Uf MOTOR CAPACITOR</td> <td>1.000</td> <td>PC</td> </tr> <tr> <td>VI1931A0</td> <td>M8x1.65 H4 CH13 ZINC PLATED NUT</td> <td>1.000</td> <td>PC</td> </tr> <tr> <td>VI1932A0</td> <td>D8 INDENTED ZINC PLATED WASHER</td> <td>1.000</td> <td>PC</td> </tr> </tbody> </table>	Code	Description	Qty	UOM	CN1003A0	6,3 Uf MOTOR CAPACITOR	1.000	PC	VI1931A0	M8x1.65 H4 CH13 ZINC PLATED NUT	1.000	PC	VI1932A0	D8 INDENTED ZINC PLATED WASHER	1.000	PC								
Code	Description	Qty	UOM																										
CN1003A0	6,3 Uf MOTOR CAPACITOR	1.000	PC																										
VI1931A0	M8x1.65 H4 CH13 ZINC PLATED NUT	1.000	PC																										
VI1932A0	D8 INDENTED ZINC PLATED WASHER	1.000	PC																										

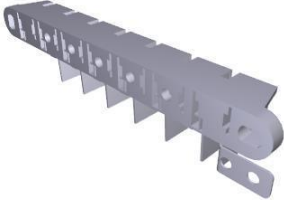



COMPONENT			SPARE PART																																																		
Code	Description	Image	Code	Description	Kit components																																																
MR1004A	41A 450V 7 POLES TERMINAL		KMR1004A	FTW 1+2+3/4+5+6 TERMINAL BLOCK KIT	<table border="1"> <thead> <tr> <th>Code</th> <th>Description</th> <th>Qty</th> <th>UOM</th> </tr> </thead> <tbody> <tr> <td>MR1004A1</td> <td>41A 450V 7 POLES TERMINAL</td> <td>1.000</td> <td>PC</td> </tr> </tbody> </table>	Code	Description	Qty	UOM	MR1004A1	41A 450V 7 POLES TERMINAL	1.000	PC																																								
Code	Description	Qty	UOM																																																		
MR1004A1	41A 450V 7 POLES TERMINAL	1.000	PC																																																		
PE1645B	12VDC Ø42MM EXTERNAL BUZZER		KPE1645B	12VDC Ø42MM EXTERNAL BUZZER KIT	<table border="1"> <thead> <tr> <th>Code</th> <th>Description</th> <th>Qty</th> <th>UOM</th> </tr> </thead> <tbody> <tr> <td>PE1645B0</td> <td>12VDC Ø42MM EXTERNAL BUZZER</td> <td>1.000</td> <td>PC</td> </tr> <tr> <td>VM1447A0</td> <td></td> <td>0.500</td> <td>PC</td> </tr> </tbody> </table>	Code	Description	Qty	UOM	PE1645B0	12VDC Ø42MM EXTERNAL BUZZER	1.000	PC	VM1447A0		0.500	PC																																				
Code	Description	Qty	UOM																																																		
PE1645B0	12VDC Ø42MM EXTERNAL BUZZER	1.000	PC																																																		
VM1447A0		0.500	PC																																																		
			KPE0002A	SBUX XP010ER-SB BOARDS UPGRADE KIT	<table border="1"> <thead> <tr> <th>Code</th> <th>Description</th> <th>Qty</th> <th>UOM</th> </tr> </thead> <tbody> <tr> <td>CE1285A0</td> <td>EMI ROUND FERRITE MOD.26438015 02</td> <td>1.000</td> <td>PC</td> </tr> <tr> <td>CE1725A0</td> <td>ROBOTICS SILICON PIPE 4x0.5 MMQ</td> <td>0.600</td> <td>M</td> </tr> <tr> <td>CE1735A0</td> <td>MINIFIT FEMALE END FITTING</td> <td>8.000</td> <td>PC</td> </tr> <tr> <td>CE1755A0</td> <td>4 WAYS MALE MINIFIT CONNECTOR</td> <td>2.000</td> <td>PC</td> </tr> <tr> <td>PE1645B0</td> <td>12VDC Ø42MM EXTERNAL BUZZER</td> <td>1.000</td> <td>PC</td> </tr> <tr> <td>PE1790C0</td> <td>SpidoCook POWER CARD</td> <td>1.000</td> <td>PC</td> </tr> <tr> <td>PE1986B1</td> <td>SB SPIDOCOOK CONTROL BOARD</td> <td>1.000</td> <td>PC</td> </tr> <tr> <td>VI1951A0</td> <td>ZINC PLATED BLACK CROSS SCREW 3,5x16</td> <td>3.000</td> <td>PC</td> </tr> <tr> <td>VM1447A0</td> <td></td> <td>1.000</td> <td>PC</td> </tr> <tr> <td>VM1745A0</td> <td>CARD SUPPORT</td> <td>7.000</td> <td>PC</td> </tr> <tr> <td>VM2022A0</td> <td>DIGITAL XP WIRING COVE</td> <td>1.000</td> <td>PC</td> </tr> </tbody> </table>	Code	Description	Qty	UOM	CE1285A0	EMI ROUND FERRITE MOD.26438015 02	1.000	PC	CE1725A0	ROBOTICS SILICON PIPE 4x0.5 MMQ	0.600	M	CE1735A0	MINIFIT FEMALE END FITTING	8.000	PC	CE1755A0	4 WAYS MALE MINIFIT CONNECTOR	2.000	PC	PE1645B0	12VDC Ø42MM EXTERNAL BUZZER	1.000	PC	PE1790C0	SpidoCook POWER CARD	1.000	PC	PE1986B1	SB SPIDOCOOK CONTROL BOARD	1.000	PC	VI1951A0	ZINC PLATED BLACK CROSS SCREW 3,5x16	3.000	PC	VM1447A0		1.000	PC	VM1745A0	CARD SUPPORT	7.000	PC	VM2022A0	DIGITAL XP WIRING COVE	1.000	PC
Code	Description	Qty	UOM																																																		
CE1285A0	EMI ROUND FERRITE MOD.26438015 02	1.000	PC																																																		
CE1725A0	ROBOTICS SILICON PIPE 4x0.5 MMQ	0.600	M																																																		
CE1735A0	MINIFIT FEMALE END FITTING	8.000	PC																																																		
CE1755A0	4 WAYS MALE MINIFIT CONNECTOR	2.000	PC																																																		
PE1645B0	12VDC Ø42MM EXTERNAL BUZZER	1.000	PC																																																		
PE1790C0	SpidoCook POWER CARD	1.000	PC																																																		
PE1986B1	SB SPIDOCOOK CONTROL BOARD	1.000	PC																																																		
VI1951A0	ZINC PLATED BLACK CROSS SCREW 3,5x16	3.000	PC																																																		
VM1447A0		1.000	PC																																																		
VM1745A0	CARD SUPPORT	7.000	PC																																																		
VM2022A0	DIGITAL XP WIRING COVE	1.000	PC																																																		

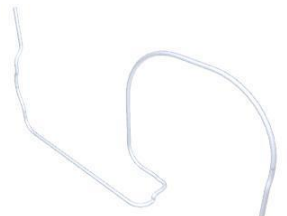

COMPONENT			SPARE PART																										
Code	Description	Image	Code	Description	Kit components																								
RC1006A	D8 PET PIPE GUIDE BEND		KRC1006A	20 PCS. Ø8 PET PIPE GUIDE BEND KI	<table border="1"> <thead> <tr> <th>Code</th> <th>Description</th> <th>Qty</th> <th>UOM</th> </tr> </thead> <tbody> <tr> <td>RC1006A0</td> <td>D8 PET PIPE GUIDE BEND</td> <td>20.000</td> <td>PC</td> </tr> </tbody> </table>	Code	Description	Qty	UOM	RC1006A0	D8 PET PIPE GUIDE BEND	20.000	PC																
Code	Description	Qty	UOM																										
RC1006A0	D8 PET PIPE GUIDE BEND	20.000	PC																										
TB3283A	TB3283A0		KTB1959A	Ø8 TB1815 TRANSPARENT PIPE 5M KIT	<table border="1"> <thead> <tr> <th>Code</th> <th>Description</th> <th>Qty</th> <th>UOM</th> </tr> </thead> <tbody> <tr> <td>TB1815A0</td> <td>7,93x4,75 PE TRANSP. PIPE (JG #PE08100N)</td> <td>5.000</td> <td>M</td> </tr> </tbody> </table>	Code	Description	Qty	UOM	TB1815A0	7,93x4,75 PE TRANSP. PIPE (JG #PE08100N)	5.000	M																
Code	Description	Qty	UOM																										
TB1815A0	7,93x4,75 PE TRANSP. PIPE (JG #PE08100N)	5.000	M																										
TR1136A	318°C -0/+24 1 POLE SAFETY THERMOSTAT		KTR1136A	318°C -0/+24 SAFETY THERMOSTAT KIT	<table border="1"> <thead> <tr> <th>Code</th> <th>Description</th> <th>Qty</th> <th>UOM</th> </tr> </thead> <tbody> <tr> <td>0H8120A0</td> <td>XEVL BULB PASS-THROU GH COVER</td> <td>1.000</td> <td>PC</td> </tr> <tr> <td>GN1531A0</td> <td>THERMOSTAT BULB INLET SEALING</td> <td>1.000</td> <td>PC</td> </tr> <tr> <td>SL1045A0</td> <td>S57 BLACK SILICONE - 80ml CARTRIDGE</td> <td>1.000</td> <td>PC</td> </tr> <tr> <td>TR1136A0</td> <td>318°C -0/+24 1 POLE SAFETY THERMOSTAT</td> <td>1.000</td> <td>PC</td> </tr> <tr> <td>VI1220A1</td> <td>4,2x12 TCB SELF-TAPPIN G SCREW</td> <td>3.000</td> <td>PC</td> </tr> </tbody> </table>	Code	Description	Qty	UOM	0H8120A0	XEVL BULB PASS-THROU GH COVER	1.000	PC	GN1531A0	THERMOSTAT BULB INLET SEALING	1.000	PC	SL1045A0	S57 BLACK SILICONE - 80ml CARTRIDGE	1.000	PC	TR1136A0	318°C -0/+24 1 POLE SAFETY THERMOSTAT	1.000	PC	VI1220A1	4,2x12 TCB SELF-TAPPIN G SCREW	3.000	PC
Code	Description	Qty	UOM																										
0H8120A0	XEVL BULB PASS-THROU GH COVER	1.000	PC																										
GN1531A0	THERMOSTAT BULB INLET SEALING	1.000	PC																										
SL1045A0	S57 BLACK SILICONE - 80ml CARTRIDGE	1.000	PC																										
TR1136A0	318°C -0/+24 1 POLE SAFETY THERMOSTAT	1.000	PC																										
VI1220A1	4,2x12 TCB SELF-TAPPIN G SCREW	3.000	PC																										
VI1328A	VI1328A0		VI1328A0	VI1328A0																									



COMPONENT			SPARE PART																		
Code	Description	Image	Code	Description	Kit components																
VM1188A	POWER BOARD WIRES PASS-THROUGH		KVM1188A	POWER BOARD WIRES PASS-THROUGH 10PCS KIT	<table border="1"> <thead> <tr> <th>Code</th> <th>Description</th> <th>Qty</th> <th>UOM</th> </tr> </thead> <tbody> <tr> <td>VM1188A0</td> <td>POWER BOARD WIRES PASS-THROUGH</td> <td>10.000</td> <td>PC</td> </tr> </tbody> </table>	Code	Description	Qty	UOM	VM1188A0	POWER BOARD WIRES PASS-THROUGH	10.000	PC								
Code	Description	Qty	UOM																		
VM1188A0	POWER BOARD WIRES PASS-THROUGH	10.000	PC																		
VM2482A	ELECTR COMPONENTS HOLDER FRAME SHOP.PRO		KVM2482A	BAKERLUX SP ELECTR COMPONENTS HOLDER KIT	<table border="1"> <thead> <tr> <th>Code</th> <th>Description</th> <th>Qty</th> <th>UOM</th> </tr> </thead> <tbody> <tr> <td>VM2482A0</td> <td>ELECTR COMPONENT S HOLDER FRAME SHOP.PRO</td> <td>1.000</td> <td>PC</td> </tr> <tr> <td>VM2484A0</td> <td>ELECTRICAL CONNECTION CABLE CLAMP</td> <td>1.000</td> <td>PC</td> </tr> </tbody> </table>	Code	Description	Qty	UOM	VM2482A0	ELECTR COMPONENT S HOLDER FRAME SHOP.PRO	1.000	PC	VM2484A0	ELECTRICAL CONNECTION CABLE CLAMP	1.000	PC				
Code	Description	Qty	UOM																		
VM2482A0	ELECTR COMPONENT S HOLDER FRAME SHOP.PRO	1.000	PC																		
VM2484A0	ELECTRICAL CONNECTION CABLE CLAMP	1.000	PC																		
VM2483A	SHOP PRO COMPONENTS HOLDER COVER		KVM2483A	BL SHOP.PRO COMPONENTS HOLDER COVER KIT	<table border="1"> <thead> <tr> <th>Code</th> <th>Description</th> <th>Qty</th> <th>UOM</th> </tr> </thead> <tbody> <tr> <td>VM2483A1</td> <td>SHOP PRO COMPONENT S HOLDER COVER</td> <td>1.000</td> <td>PC</td> </tr> </tbody> </table>	Code	Description	Qty	UOM	VM2483A1	SHOP PRO COMPONENT S HOLDER COVER	1.000	PC								
Code	Description	Qty	UOM																		
VM2483A1	SHOP PRO COMPONENT S HOLDER COVER	1.000	PC																		
VM2484A	ELECTRICAL CONNECTION CABLE CLAMP		KVM2484A KVM2482A	CABLE LOCKS ELECTRICAL CONNECTION KIT BAKERLUX SP ELECTR COMPONENTS HOLDER KIT	<table border="1"> <thead> <tr> <th>Code</th> <th>Description</th> <th>Qty</th> <th>UOM</th> </tr> </thead> <tbody> <tr> <td>VM2484A0</td> <td>ELECTRICAL CONNECTION CABLE CLAMP</td> <td>1.000</td> <td>PC</td> </tr> <tr> <td>VM2482A0</td> <td>ELECTR COMPONENT S HOLDER FRAME SHOP.PRO</td> <td>1.000</td> <td>PC</td> </tr> <tr> <td>VM2484A0</td> <td>ELECTRICAL CONNECTION CABLE CLAMP</td> <td>1.000</td> <td>PC</td> </tr> </tbody> </table>	Code	Description	Qty	UOM	VM2484A0	ELECTRICAL CONNECTION CABLE CLAMP	1.000	PC	VM2482A0	ELECTR COMPONENT S HOLDER FRAME SHOP.PRO	1.000	PC	VM2484A0	ELECTRICAL CONNECTION CABLE CLAMP	1.000	PC
Code	Description	Qty	UOM																		
VM2484A0	ELECTRICAL CONNECTION CABLE CLAMP	1.000	PC																		
VM2482A0	ELECTR COMPONENT S HOLDER FRAME SHOP.PRO	1.000	PC																		
VM2484A0	ELECTRICAL CONNECTION CABLE CLAMP	1.000	PC																		